



OPERATING INSTRUCTIONS **EN**

ISTRUZIONI D'USO **IT**

NOTICE D'UTILISATION **FR**

BEDIENUNGSANLEITUNG **DE**

INSTRUCCIONES DE USO **ES**

INSTRUÇÕES DE FUNCIONAMENTO **PT**

ULISSE **ECO**

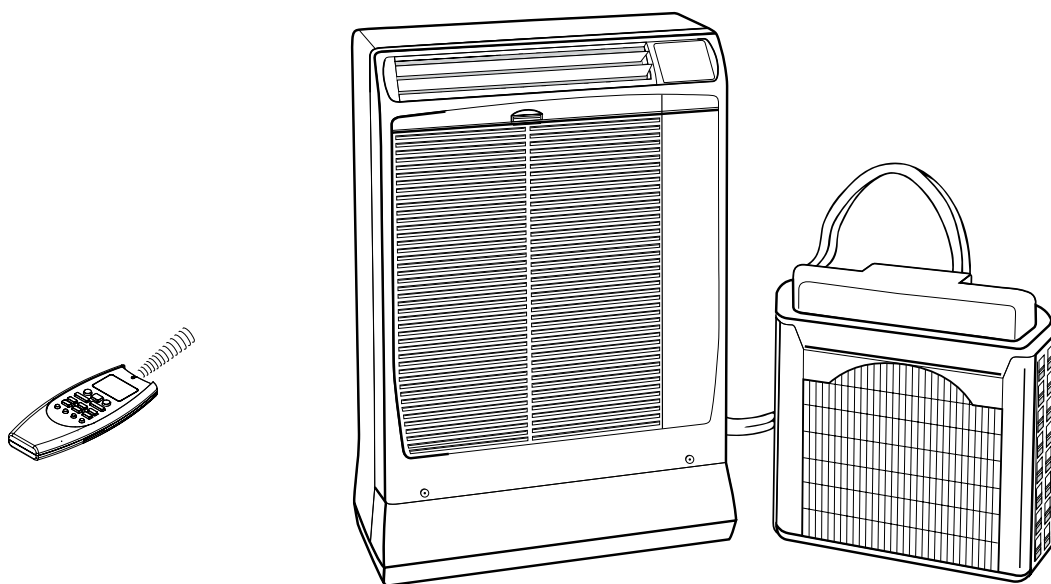

Room air conditioner with remote condenser
Condizionatore d'ambiente con condensatore remoto
Climatiseur avec condenseur a air exterieur - Klimagerät mit außengerät
Acondicionador de ambiente con condensador a distancia
Ar Condicionado com condensador remoto

CONTENTS

EN

SAFETY INSTRUCTIONS	2
INSTALLATION LOCATION.....	3
ELECTRICAL REQUIREMENTS	3
PRODUCT IDENTIFICATION.....	4
MONITOR PANEL	4
AIR CONDITIONER INSTALLATION.....	5
IMPORTANT ADVICE	5
USING THE REMOTE CONTROL UNIT	6
REMOTE CONTROL UNIT	7
HOW TO SET THE PRESENT TIME	8
COOLING	8
DEHUMIDIFYING (DRY)	8
FAN ONLY	8
ADJUSTING THE FAN SPEED	8
NIGHT MODE/ENERGY SAVING	8
HIGH POWER MODE	9
SETTING THE TIMER.....	9
SETTING 1 HR TIMER.....	9
ADJUSTING THE AIR FLOW DIRECTION.....	10
OPERATION WITHOUT THE REMOTE CONTROL UNIT.....	10
CARE AND CLEANING.....	10
ACCESSORIES (SUPPLIED ON REQUEST)	11
TIPS FOR ENERGY SAVING	12
TROUBLESHOOTING	12
MATCH BETWEEN REMOTE CONTROLLER AND THE UNIT.....	13

PRODUCT INFORMATION

If you have problems or questions concerning your Air Conditioner, you will need the following information. Model and serial numbers are on the nameplate on the bottom of the air conditioner.

Model No.

Serial No.

Date of purchase

Dealer's address

Phone number

ALERT SYMBOLS

The following symbols used in this manual, alert you to potentially dangerous conditions to users, service personnel or the appliance:



WARNING

This symbol refers to a hazard or unsafe practice which can result in severe personal injury or death.



CAUTION

This symbol refers to a hazard or unsafe practice which can result in personal injury or product or property damage.

SAFETY INSTRUCTIONS



• **Read this booklet carefully before using this air conditioner. If you still have any difficulties or problems, consult your dealer for help.**

- **This air conditioner is designed to give you comfortable room conditions for domestic use. As far as industrial and professional activities are concerned, Argoclima declines all responsibility for any unsuitability of the appliance depending on its characteristics and the purposes it should be responsible for.**



WARNING

- Never use or store gasoline or other flammable vapour or liquid near the air conditioner. It is very dangerous. **Moreover, never install electrical equipment, which is not protected with IPX1 protection (protection against vertical water drop), under the unit.**
- The manufacturer assumes no responsibilities if the safety regulations or local codes are not observed.



CAUTION

- **Never use neither the power main switch or the power plug to start or stop the air conditioner. Always use the ON/OFF button.**
- **Do not stick anything into the air outlet of the air conditioner. This is dangerous because the fan is rotating at high speed.**
- **Do not let children play with the air conditioner.**
- **Do not cool the room too much if babies or invalids are present.**
- **This air conditioner can be used by children aged from 8 years and above and persons with reduced physical, sensory or mental capabilities or lack of experience and knowledge if they have been given supervision or instruction concerning use of the air conditioner in a safe way and understand the hazards involved.**
- **Cleaning and user maintenance shall not be made by children without supervision.**
- **For safety, be sure to turn the air conditioner off and also to disconnect the power before cleaning.**

INSTALLATION LOCATION



WARNING

- Do not install this air conditioner where there are fumes or flammable gases, or in an extremely humid space such as a green house.
- Do not install the air conditioner where excessively high heat-generating objects are placed.
- Do not install the air conditioner where the atmosphere is extremely damp or humid (e.g. greenhouse or laundry) it could be wetted by drops of water (i.e. in laundries).

Avoid:

To protect the air conditioner from heavy corrosion, avoid installing the outdoor unit where salty sea water can splash directly onto it or in sulphurous air near a spa.

- Make sure that there are no obstacles around the indoor unit affecting the free circulation of air. Do not block the air intake and outlet of the unit with curtains or other. Never put objects on the top of the unit.

ELECTRICAL REQUIREMENTS

EN

Before using the appliance

- Check that the power supply at the location where the air conditioner is going to be used is 220/240 volt, single phase.
- For your safety care check periodically the conditions of the electric supply cable; the electrical connection of the unit is Y type with cable prepared in a special way; in case you should notice any damage due to usage, call the nearest After Sale Service to get the cable replaced.
- Before connecting the air conditioner to a power socket, make sure that the socket is provided with an earth connection.
- Verify that the available power supply is sufficient for running other electrical domestic appliances in use simultaneously from the same supply. See the data plate on the unit showing the max. absorbed powers.
- Install a double - pole switch, protected fuses of the delayed type, upstream the electricity wall socket 10A.
- Make sure that circuit breakers, fuses, etc. are of sufficient capacity to handle start - up current (normally for no longer than a second).
- All wiring must conform to the local electrical codes. Consult your dealer or a qualified electrician for details.

WARNING!

The air conditioner is provided with a time-guard system, which does not allow re-starting of compressor until after 3 minutes from a previous stop.

NOTE

This air conditioner is equipped with cooling, drying and fan functions.

Details on these functions are provided here following; refer on these descriptions when using the air conditioner.

OPERATING LIMITS		
COOLING		
MAXIMUM CONDITIONS	OUTDOOR TEMPERATURE	46°C D.B.
	ROOM TEMPERATURE	32°C D.B./23°C W.B.
MINIMUM CONDITIONS	OUTDOOR TEMPERATURE	19°C D.B.
	ROOM TEMPERATURE	19°C D.B./14°C W.B.

PRODUCT IDENTIFICATION

EN

1. Infrared rays remote control unit
2. Monitor panel
3. Supply air deflector
4. Return air grille
5. Outdoor unit
6. Flexible tube
7. Air filter
8. Electric cable with plug
9. Service tube for condensate evacuation
10. Outdoor unit basket or support
11. Quick coupling cover

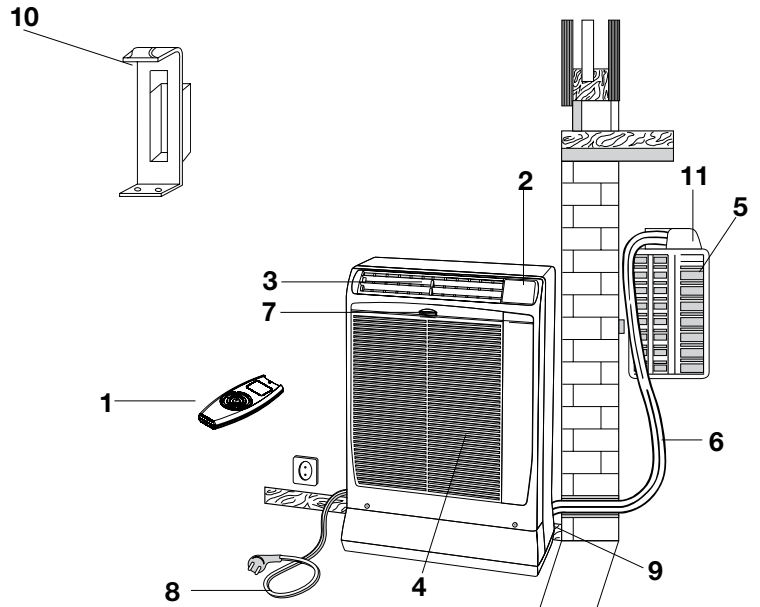

MONITOR PANEL

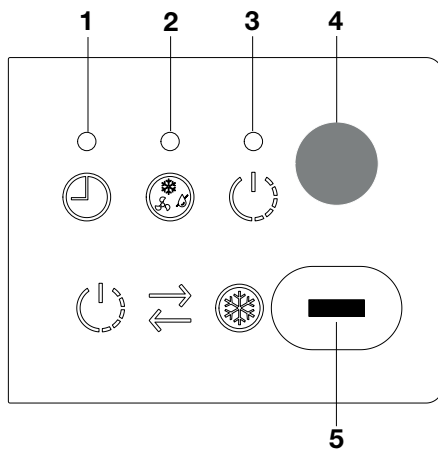

1. **TIMER lamp:** This lamp lights up when the system is being controlled by the timer.
2. **OPERATION lamp:** This lamp lights up during operation. It blinks once to announce that the remote control signal has been received and stored.



WATER-LEVEL ALARM

This lamp flashes and the air conditioner simultaneously stops during exceeding condensate drainage or because of malfunctioning of the condensate drainage system.

3. **STANDBY lamp:** this lamp lights up when the air conditioner is connected to the power and ready to receive the remote control command.
4. **Receiver :** receives signals transmitted from the remote control.

5. **Operation button (without remote control):** Push the button to walk through the OFF and COOL operation modes.



WARNING

The OFF position does not disconnect the power. Use the main power switch to turn off power completely.

NOTE

The fixed OPERATION lamp and the blinking of TIMER and STANDBY lamps, indicates that the operating mode selected () is not compatible with the unit. If this happen the air conditioner does not operate until the correct mode is selected.

The air conditioner is made of two units interconnected by a flexible tube. The indoor unit must be placed in the room to be air conditioned, near a window, a balcony-door or a perimeter wall. The outdoor unit, that provides to the disposal of heat and condensation, must be located outside, on a window sill, on a balcony or hanged to the wall.

POSITIONING OF OUTDOOR UNIT

The outdoor unit must always be kept in vertical position and levelled. Make sure that there are no obstacles around the unit affecting the free circulation of air. A lug at the rear bottom of the unit ensures the minimum distance from the wall (3 cm). The unit must be kept at a minimum distance of cm. 15 (sidewise) and cm. 80 (frontally) from any walls.

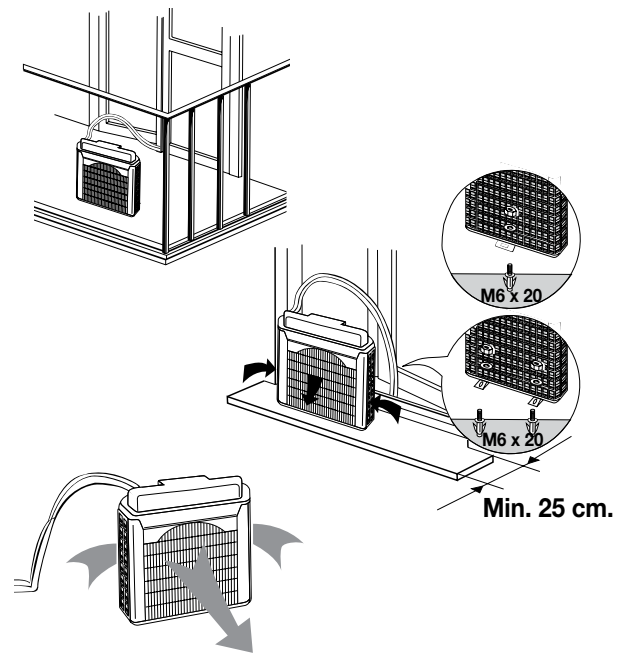

TYPE A

INSTALLATION TYPE A

If your room has a balcony or a window-sill of sufficient depth (min. 25 cm) you may rest the unit freely onto it. For safety's sake, you may anchor the unit to the window-sill using one M6 x 20 expansion bolt in the slot of the lug at the rear bottom of the unit.

The flexible tube may easily pass through the balcony door or window shutters set ajar.

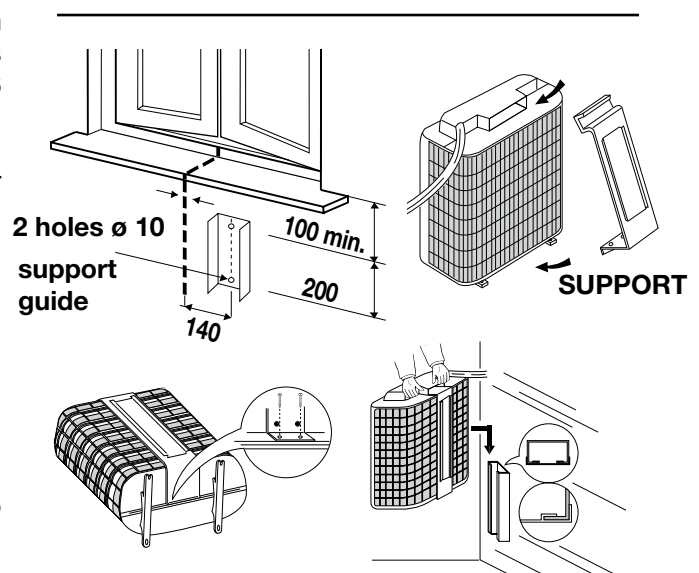

TYPE B

INSTALLATION TYPE B (USING THE SUPPORT)

1. Fix the support guide to the wall below the window sill.
2. Insert the support in the handle of outdoor unit, and turn the outdoor unit upside down as shown in the picture.
3. Place the support and secure it at the edge of the unit, using the screws.
4. Insert the support, fixed on the unit, at the guide fixed to the wall. Make sure it is levelled.

IMPORTANT ADVICE

OUTDOOR UNIT

1. When you move the outdoor unit, always hold it by the handle, never pull it by the flexible tube.
2. Never let the outdoor unit hang on the flexible tube.
3. When you recover the outdoor unit after operation, drain away any remaining condensate by tilting the unit.

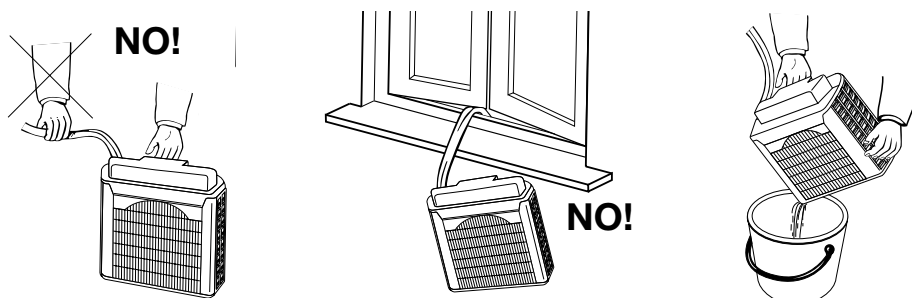

USING THE REMOTE CONTROL UNIT

EN

HOW TO INSTALL BATTERIES

- Remove the lid in the rear part of the remote control unit and check the settings of the microswitches as shown below:

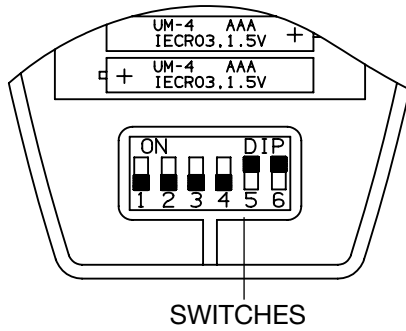

- Insert two AAA alkaline batteries of 1,5 V-DC making sure that point in the direction marked in the battery compartment. The displayed time flashes. Press the SEL TYPE button. Remote controller is now ready for operation.
- The batteries last about six months. Depending on how much you use the remote control unit. Remove the batteries if you do not use the remote control unit for more than one month. Replace the batteries when the remote control unit lamp fails to light, or when the air conditioner does not receive the remote control unit signals.
- The batteries of the remote control contain polluted substances exhausted batteries must be disposed according to the laws in force.

HOW TO REMOVE BATTERIES

- Remove the lid.
- Press the battery toward the negative end and lift it out by its positive end (as shown in the figure).
- Remove the other battery in the same way.

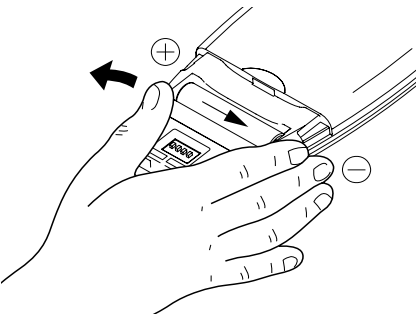

TEMPERATURE SENSOR SELECTOR

- Under normal conditions the room temperature is detected and checked by the temperature sensor placed in the remote controller (I FEEL icon displayed). This function is designed to provide a comfortable room temperature by transmitting the temperature control command from the location next to you. When using this function, the remote control should always be pointed at the air conditioner, therefore it should be placed in a position in which it is visible by the indoor unit (for example, do not put it in a drawer).
- It is possible to disable the remote controller room sensor pressing the I FEEL button. In this case the I FEEL icon on the remote controller display lights off and the sensor placed in the air conditioner becomes active.

NOTE

The remote control unit transmits signals to the indoor unit each time you press a key and at any temperature change detected by the IFEEL sensor. In case of troubles (low batteries, remote control placed in a position not visible by the indoor unit,...) room temperature control is automatically switched to the sensor of the indoor unit. In this case, the temperature around the remote control unit may differ from the temperature detected in the air conditioner position.

OPERATION WITH THE REMOTE CONTROL UNIT

When using the remote control unit, always point the unit transmitter head directly at the air conditioner receiver.

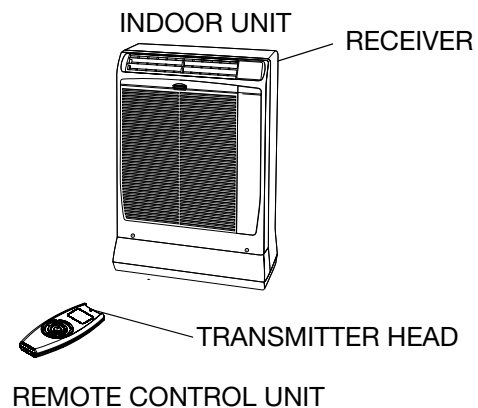

REMOTE CONTROL UNIT

DISPLAY

Information is displayed when the remote controller is switched on. If switched off, only the operating mode, the room temperature and the clock are shown

I FEEL mode is active (remote controller sensor active)

Operation mode

- Automatic
- Cooling
- Dehumidification
- Fan

Night mode

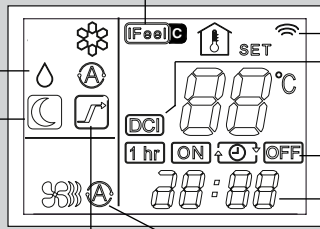

- Displayed when transmitting data
- Inverter model
- Timer modes
- Clock

Room temperature

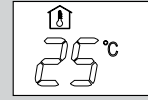

Set point temperature

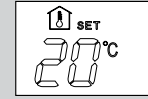

HIGH POWER mode

Fan speed

- Automatic
- High speed
- Medium speed
- Low speed

MODE SELECTOR BUTTON

Press this button to modify the air conditioner mode.

(cooling)

(automatic)



The air conditioner makes the room cooler.

(dry)

The air conditioner reduces the humidity in the room.

(fan)

The air conditioner works only as a circulation fan.

SENSOR

A temperature sensor inside the remote control unit detects the room temperature.

TRANSMITTER

When you press the buttons of the remote control unit, the mark appears on the display to transmit the setting changes to the receiver in the air conditioner.

NOT AVAILABLE OPERATION MODE

ON/OFF BUTTON
This button turns the air conditioner ON and OFF.

INACTIVE BUTTON

IFEEL/IFEEL C SENSOR SELECTOR

Press this button to modify the active setting for room temperature detection (from remote controller to air conditioner and viceversa).

INACTIVE BUTTONS

TIMER SELECTION BUTTON

Press this button to select the type of timer to activate. For details refer to paragraph "SETTING THE TIMER".

TEMPERATURE SETTING BUTTONS

- (cooler)

Press this button to decrease the set temperature.

+ (warmer)

Press this button to increase the set temperature.

"FAN" BUTTON (fan speed)

Fan speed is automatically selected by the microcomputer.

High speed.

Medium speed.

Low speed.

NIGHT/ECO BUTTON

Press this button in order to select the NIGHT/ECO mode.

"HIGH POWER" BUTTON

Press this button in order to select the HIGH POWER mode.

CLOCK AND TIMER SETTING BUTTON

Press this button in order to:

- set the clock
 - set the ON/OFF timer
- For details refer to paragraphs "SETTING THE HOUR" and "SETTING THE TIMER".

HOURS AND MINUTES SETTING BUTTONS

With these buttons is possible to set the clock and the timer. For details refer to paragraphs "SETTING THE HOUR" and "SETTING THE TIMER".

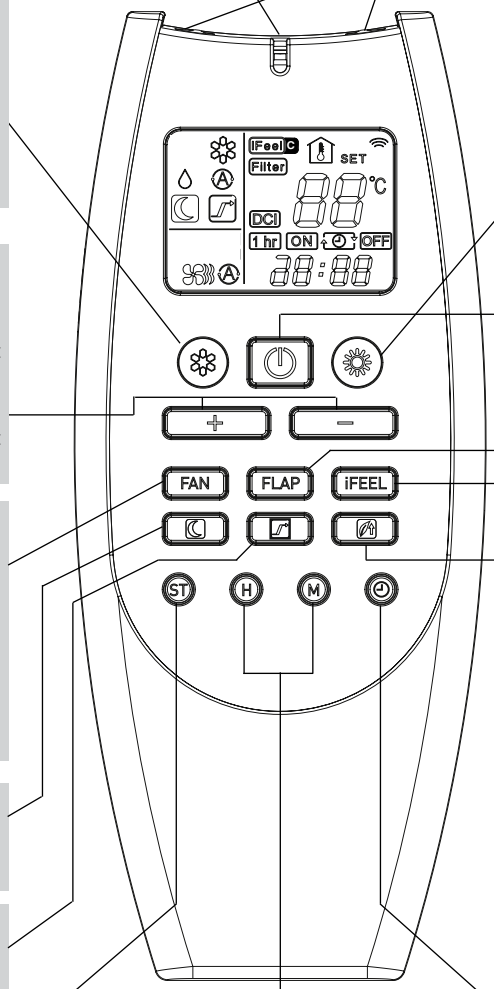



HOW TO SET THE PRESENT TIME

- EN**
1. Press the button SEL TYPE three times.
The time indication alone flashes.
 2. Press the SET H button until the present time hour is displayed.
Press the SET M button until the present time minutes are displayed. The display will automatically stop flashing.

COOLING / AUTOMATIC

NOTE

Verify that the unit is connected to the main power and the STANDBY lamp is light up.

1. Set the  selector to COOL (symbol  on the display).
2. Press the +/- buttons (temperature selection) to set the desired temperature (the temperature range is between 32 °C max. and 10 °C min.).

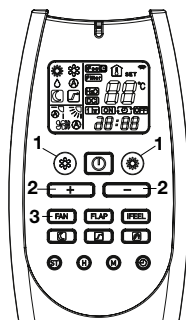



THE DISPLAY SHOWS THE SELECTED TEMPERATURE.



AFTER 5 SECONDS FROM THE REQUIRED TEMPERATURE SETTING THE DISPLAY WILL SHOW THE ROOM TEMPERATURE AGAIN.

3. Press the FAN button to select the fan speed.

DEHUMIDIFYING (DRY)

1. Set the  button to DRY. The icon  is displayed.
2. Press the +/- buttons (temperature selection) to set the desired temperature (the temperature range is between 32 °C max. and 10 °C min.).



THE DISPLAY SHOWS THE SELECTED TEMPERATURE.





AFTER 5 SECONDS FROM THE REQUIRED TEMPERATURE SETTING THE DISPLAY WILL SHOW THE ROOM TEMPERATURE AGAIN.

NOTE

- Use DRY operation when you want to reduce the humidity in the room.
- Once the room temperature reaches the set level, the unit repeats the cycle of turning on and off automatically.
- During DRY operation, the fan speed is automatically set (Remote control lamp  is ON) to prevent overcooling.
- Dry operation is not possible if the indoor temperature is 10 °C or less.

FAN ONLY

If you want to make air circulate without any temperature control, press  button until only the  fan symbol appears on the display.

ADJUSTING THE FAN SPEED

AUTOMATIC



Simply set the FAN selector to the  position. A microcomputer automatically controls the fan speed when the AUTO mode is selected. When the air conditioner starts operating, the fan speed varies (high - medium - low - very low) according to the thermal load of the room.

NOTE

The automatic speed is not available in FAN ONLY mode.



MANUAL

If you want to manually adjust speed just set the FAN selector as desired.

 High speed  Med. speed  Low speed

NIGHT MODE / ENERGY SAVING

- This mode enables you to save energy.

1. Set the  selector to cool or dry.
2. Press the  button.
3. The  mark appears on the display. Press the button again to release the function.

What does the NIGHT mode mean?

When you select the NIGHT mode, the air conditioner will modify automatically the set temperature after 60 minutes: it will be raised by 1°C.



This enables you to save energy without sacrificing your comfort.

NOTA

During the NIGHT mode the internal fan speed is automatically lowered and reduces the noise.

HIGH POWER MODE

You can select High Power only during cooling mode and not during dehumidifying (dry) and fan mode. High Power mode allows to obtain the maximum air conditioner's efficiency. The user can choose to activate the High Power mode, using the remote control unit, after having selected cooling mode. Under these conditions the air conditioner will reach its maximum thermal power and consequently also the maximum electrical consumption and noise. On the contrary, if you want to obtain the best performance in efficiency and silentness, High Power mode is not recommended: let the air conditioner run in normal condition (factory default program).

To activate High Power mode it is necessary (after having selected the cooling mode) to press the HIGH POWER button  : the symbol  switches on; at this point the operation lamp (green lamp on the front panel of the air conditioner) begins blinking slowly, indicating that High Power mode is activated; press the button again to release the function: therefore the green lamp will stop blinking and it will be switched on permanently.

NOTES

- During the high power operation the room temperature could not correspond to the set temperature.
- HIGH POWER program remains set also if you switch OFF and ON again the air conditioner.

SETTING THE TIMER

A) HOW TO SET THE ON TIME

1. Press the ST button once.
The ON and time indications flash.
2. Press the H button until the designed hour is displayed.
Press the M button until the designed minutes are displayed. The display will change automatically back to show the present time after 10 sec.
3. Press the ON/OFF button to start the air conditioner.
4. Press the  button to activate the ON timer.

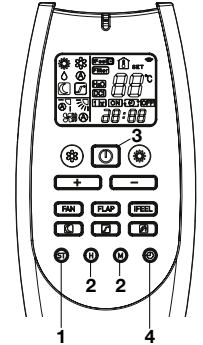
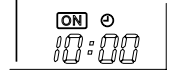

B) HOW TO SET THE OFF TIME

1. Press the ST button twice.
The OFF and time indications flash.
2. Press the H button until the designed hour is displayed.
Press the M button until the designed minutes are displayed. The display will change automatically back to show the present time after 10 sec.
3. Press the ON/OFF button to start the air conditioner.
4. Press the  button two times to activate the OFF timer.

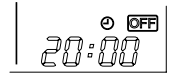

C) HOW TO SET A PROGRAM FOR DAILY ON/OFF OPERATION (OR VICEVERSA)

1. Set the timer ON/OFF as shown in A) and B).
2. Press the ON/OFF button to start the air conditioner.
3. Press three times the  button to activate the DAILY timer.



NOTE

After timer setting, press ST button in order to check the ON/OFF setting time.

SETTING THE 1 HOUR TIMER

This function causes the unit to operate for one hour at the set conditions, regardless of whether the unit is on or off.

TIMER SETTING PROCEDURE.

- Press four times the  button. The 1 HOUR TIMER mark will appear on the display.

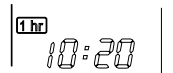

CANCELLATION PROCEDURE

- Press the ON/OFF button to turn the air conditioner off.
- Wait for the indoor unit to stop operating.
- Press the ON/OFF button again to turn the air conditioner on.

ADJUSTING THE AIR FLOW DIRECTION

EN VERTICAL

Hold the end of the flap and move it up and down to adjust the vertical air flow.

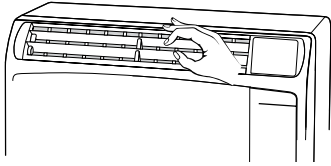

HORIZONTAL

The horizontal air flow can be adjusted by moving the vertical blades to the left or right, as indicated in the following figure.

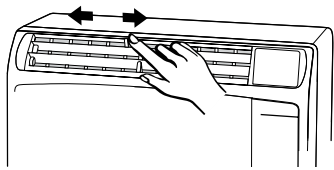

CAUTION

Set vertical blades to the front position during **COOLING/DRY** operation if humidity is high. If the vertical blades are set to the left-most or right-most position, condensation will form around the air outlet and drip off.

OPERATION WITHOUT THE REMOTE CONTROL UNIT

If you have lost the remote control unit or it has troubles, follow the steps below.

1. WHEN THE AIR CONDITIONER IS STOPPED

If you want to turn on the air conditioner push the **OPERATION BUTTON** to select the **COOL** mode:

NOTE

The air conditioner will start in **HIGH** fan speed. The temperature setting is **25°C**.

2. WHEN THE AIR CONDITIONER IS RUNNING

If you want to turn off the air conditioner push the **OPERATION BUTTON** until the **OPERATION** lamp is turned off.

NOTE

Power failure during operation.

In the event of power failure, the unit will stop. When the power is resumed, the unit automatically restarts after 3 minutes.

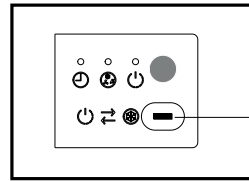

OPERATION BUTTON

CARE AND CLEANING



CAUTION

For safety, be sure to turn the air conditioner off and also to disconnect the power before cleaning.

OUTDOOR UNIT (CASING AND CONDENSING COIL)

- Some metal edges and the condenser fins are sharp and may cause injury if handled improperly; special care should be taken when you clean these parts.
- Periodically check the outdoor unit to see if the air outlet or air intake are clogged up with dirt or soot.
- The condenser and other components of the outdoor unit must be cleaned periodically. Consult your **DEALER** or **AFTER SALES SERVICE**.

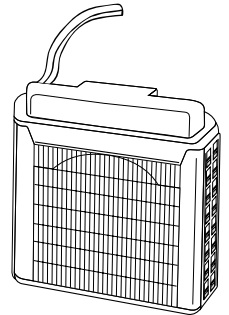

INDOOR UNIT

- Do not pour water on the unit to clean it. This will damage the internal components and cause an electric shock hazard.
- Never use solvents, or chemical agents when cleaning the indoor unit. Do not wipe the plastic casing using very hot water.

Casing and Grille

Clean the casing and grille of the indoor unit with a vacuum cleaner brush, or wipe them with a clean, soft cloth. If these parts are stained, use a clean cloth moistened with a mild liquid detergent. When cleaning the grille, be careful not to force the blades out of place.

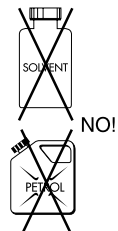
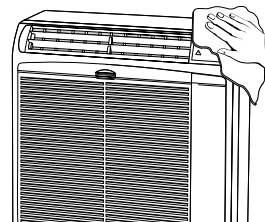

AIR FILTER

The air filter must be checked at least once every two weeks operation. Operation with a dirty filter always causes a lower efficiency of the air conditioner and severe product damage. The filter is located at the back of the intake grille in the front of the air-conditioner and shall be removed from the upper side of the unit.

HOW TO REMOVE THE FILTER

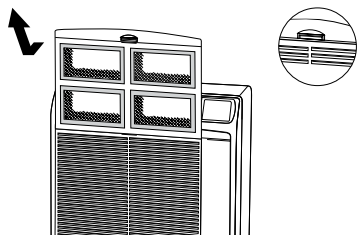

FILTER CLEANING

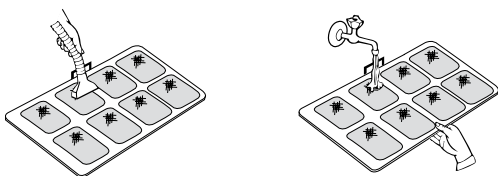

Use a vacuum cleaner to remove light dust. If there is sticky dust on the filter, wash the filter in lukewarm, soapy water, rinse it in clean water, and dry it.

TRANSPORT

Preferably keep the air conditioner in the vertical position during transportation. If this is not possible, then lay it on one side; when at destination put the air conditioner back in the vertical position and wait at least 10 minutes before using it.

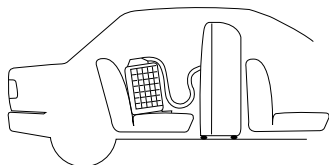

STORAGE

If you are not going to use the air-conditioner for a long period, clean the air filters, evacuate the condensate from the indoor unit through the drain hose at the unit back side. Do not disconnect the flexible tube, unless you are obliged to do it: in that case protect the open halves of the couplings with the plugs supplied as accessories, that must be tightened with a spanner. Do not put heavy objects on the top of the unit, and protect it with a cloth or a plastic bag.

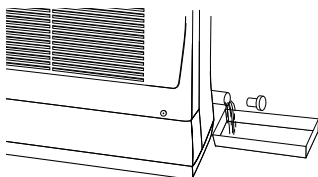

CONDENSATE DRAIN PIPE

ACCESSORIES (SUPPLIED ON REQUEST)

EN

SUPPLEMENTARY SUPPORT GUIDE KIT FOR OUTDOOR UNIT

If you want to utilise the air conditioner in several rooms, it is possible to buy various support guides for the installation of outdoor unit.

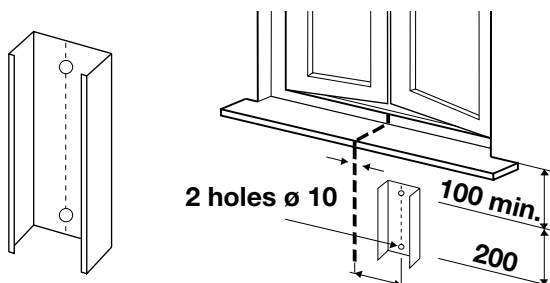

SUPPORT GUIDE

TIPS FOR ENERGY SAVING

EN DO NOT:

- Block the air intake and outlet of the unit. If they are obstructed, the unit will not work well, and may be damaged.
- Let direct sunlight into the room. Use sunshades, blind or curtain.

DO:

- Always try to keep the air filter clean. A clogged filter will impair the performance of the unit.
- To prevent conditioned air from escaping, keep windows, doors and any other openings closed.

TROUBLESHOOTING

- The use of portable telephones near the air-conditioner may cause disturbance to its normal operation and must be avoided. In case abnormal operation is noticed, (OPERATION lamp lights but outdoor unit will not run) to restore normal operation turn-off electric supply for 60 seconds at least, by disconnecting the main switch or the wall plug, then start again the air-conditioner.

- The blinking OPERATION lamp, together with the stop of the air conditioner for a short time are due to the exceeding condensate drainage.

If the OPERATION lamp goes on blinking and the air conditioner definitely stops means that the condensate pump is not working or that the condensate drain pipe in the flexible connection pipe is obstructed; in this case contact the AFTER SALE SERVICE.

In case of emergency the air conditioner can work by draining the condensate from the back little pipe into a rather short container: extract the little pipe and remove the cap.

- If your air conditioner does not work properly, first check the following points before requesting service. If it still does not work properly, contact your dealer or service center.

Trouble: the air conditioner does not run at all.

Possible cause:

1. Power failure.
2. Leakage breaker tripped.
3. Line voltage is too low.
4. Operation button is OFF.
5. Batteries in remote control unit have run down.

Remedy:

1. Restore power.
2. Contact service center.
3. Consult your electrician or dealer.
4. Press the button again.
5. Replace batteries.

Trouble: Compressor runs but soon stops.

Possible cause:

1. Obstruction in front of condenser coil.

Remedy:

1. Remove obstruction.

Trouble: Poor cooling performance.

Possible cause:

1. Dirty or clogged air filter.
2. Heat source or many people in room.
3. Doors and/or windows are open.
4. Obstacle near air intake or air discharge port.
5. Thermostat is set too high.

Remedy:

1. Clean air filter to improve airflow.
2. Eliminate heat source if possible.
3. Shut them to keep the heat or cold out.
4. Remove it to ensure good airflow.
5. Set the temperature lower.

Trouble: Clicking sound is heard from the air conditioner.

Possible cause:

1. Any plastic parts may expand or shrink due to a sudden temperature change. In this event, a clicking sound may occur.

Remedy:

1. This is normal, and the sound will disappear when an even temperature is settled.

NOTE

The fixed OPERATION lamp and the blinking of TIMER and STANDBY lamps, indicates that the operating mode selected () is not compatible with the unit. If this happen the air conditioner does not operate until the correct mode is selected.

AUTO-DIAGNOSIS

LEDS			POSSIBLE CAUSE	REMEDY
STANDBY	OPERATION	TIMER		
F	F	O	Defective indoor air sensor	Contact service centre
O	F	F	Defective indoor air coil sensor	Contact service centre
F	O	O	Defective compressor discharge temperature sensor	Contact service centre
F	●	O	Multifunctioning of electronic PCB (current protection)	Contact service centre
F	O	●	Multifunctioning of electronic PCB (temperature protection)	Contact service centre
F	●	●	Multifunctioning of PFC (power factor correction system)	Contact service centre
O	F	O	Multifunctioning of the condensate drainage system	Contact service centre

O = LED OFF

● = LED ON

F = Flashing LED

MATCH BETWEEN REMOTE CONTROLLER AND THE UNIT

The remote control can be addressed for 4 different units installed in open space or similar:

-you can get unified control with only one remote control up to 4 units

or

-each remote control is addressed to its unit, so that it can control separately the temperature, the timer and all the other functions.

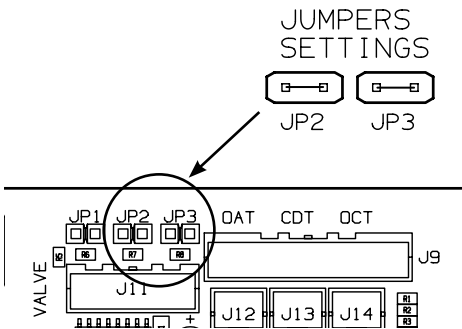

Proceed as follows:

- Disconnect the power of the unit.
 - Remove the batteries from the remote control unit.
 - Set the microswitches (see table).
 - Insert the batteries in the remote control unit.
 - Switch on the unit.
- At this point the unit starts operating with the new address.

Set JP2 and JP3 as shown in the table.

UNIT	REMOTE CONTROL UNIT	PCB
1 FACTORY STATE	<p>1=OFF 2=OFF 3= OFF 4=OFF 5=ON 6=ON</p>	<p>JP2=CLOSE JP3=CLOSE</p>
2	<p>1=ON 2=OFF 3=OFF 4=OFF 5=ON 6=ON</p>	<p>JP2=OPEN JP3=CLOSE</p>
3	<p>1=OFF 2=ON 3=OFF 4=OFF 5=ON 6=ON</p>	<p>JP2=CLOSE JP3=OPEN</p>
4	<p>1=ON 2=ON 3=OFF 4=OFF 5=ON 6=ON</p>	<p>JP2=OPEN JP3=OPEN</p>

**INFORMATION FOR CORRECT DISPOSAL OF THE PRODUCT IN ACCORDANCE WITH THE EUROPEAN DIRECTIVE 2012/19/EU**

At the end of its working life this equipment must not be disposed of as an household waste. It must be taken to special local community waste collection centres or to a dealer providing this service. Disposing of an electrical and electronic equipment separately avoids possible negative effects on the environment and human health deriving from an inappropriate disposal and enables its components to be recovered and recycled to obtain significant savings in energy and resources. In order to underline the duty to dispose of this equipment separately, the product is marked with a crossed-out dustbin.

**INFORMATION FOR CORRECT DISPOSAL OF THE BATTERY IN ACCORDANCE WITH THE EUROPEAN DIRECTIVE 2006/66/EC**

Please replace battery when its electricity charge is used up: please do not eliminate this battery together with normal household waste. It must be taken to special local community waste collection centres or to a dealer providing this service. Disposing of a battery separately avoids possible negative effects on the environment and human health deriving from an inappropriate disposal and enables its components to be recovered and recycled to obtain significant savings in energy and resources. In order to underline the duty to dispose of this equipment separately, the battery is marked with a crossed-out dustbin.

REGULATION (EU) No. 517/2014 - F-GAS

The unit contains R32, a fluorinated greenhouse gas with a global warming potential (GWP) of 675. Do not release R32 into the atmosphere.

argoclima S.p.A.

Via Alfeno Varo, 35 - 25020 Alfianello - BS - Italy

Tel. +39 0331 755111 - Fax +39 0331 755501

www.argoclima.com