

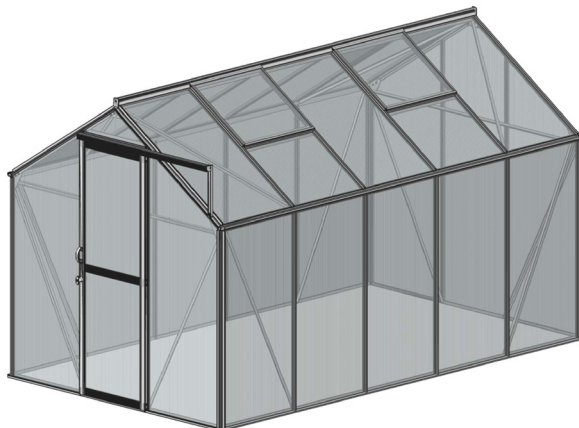

**GREEN
LAND**



FI EN SE

Galea 7,5 m² kasvihuone
Galea 7,5 m² greenhouse
Galea 7,5 m² växthus

**KASVIHUONEEN KOKOAMINEN
ASSEMBLING THE GREENHOUSE
MONTERING AV VÄXTHUSET**

Valmistuttaja/Produced for:

SUOMITRADING.fi

Areenakatu 7, 37570 Lempäälä

+358 (0)10 430 3490

Made in China





GREEN
LAND

Galea 7,5 m² kasvihuone

Onnittelut uuden Green Land Galea -kasvihuoneen oston johdosta. Toivomme, että kasvihuone tuo iloa puutarhanhoitoon ja menestystä kasvien ja vihannesten kasvattamiseen. Lue alla olevat kokoonpano-ohjeet huolellisesti ennen kokoonpanon aloittamista ja varmista, että sinulla on kaikki osaluettelossa luetellut osat sekä kokoonpanossa tarvittavat työkalut. Säilytä käyttöopas myöhempää tarvetta varten.

TEKNISET TIEDOT

- » **LEVEYS: 212,5 CM**
- » **PITUUS: 354,3 CM**
- » **KORKEUS (SOKKELIN KANSSA): 140/219,5 CM**
- » **PAINO: 245 KG**
- » **KOKO: 7,53 M²**
- » **RUNGON VÄRI: MUSTA**
- » **RUNGON MATERIAALI: ALUMIINI**
- » **RUNGON PAKSUUS: 1,3–3,0 MM**
- » **KATTO- JA SEINÄPANEELIT: 3 MM:N KARKAISTU TURVALASI**
- » **SOKKELI: 10 CM KORKEA ALUMIINISOKKELI**
- » **TUULETUSAUKOT: KAKSI KÄSIN AVATTAVAA KATTOAUKKOA**
- » **OVI: LUKITTAVA LIUKUOVI**
- » **TAKUU: 10 VUOTTA RUNGON OSALTA**

VAROITUKSET JA ILMOITUKSET

- » *Tutustu paikallisiin lakeihin ja määräyksiin ennen kasvihuoneen kokoamista.*
- » *Etsi kasvihuoneelle tasainen ja tukeva paikka. Jos maa tai perustus ei ole tasainen, älä asenna kasvihuonetta siihen paikkaan. Aloita varmistamalla, että perustus on tasainen.*
- » *Asenna kasvihuone vain hyvissä sääolosuhteissa. Älä kokoja kasvihuonetta tuulisena päivänä.*
- » *On suositeltavaa, että kasvihuone kootaan vähintään 2–3 henkilön voimin.*
- » *Huomaa, että kasvihuone koostuu monista osista ja tarvikkeista, ja sen kokoaminen vie aikaa.*
- » *Valitse paikka, jossa sinulla on riittävästi tilaa työskennellä kasvihuoneen ympärillä.*
- » *Käytä suojakäsineitä ja pitkähihaista paitaa, kun kokoat kasvihuonetta. Siinä saattaa olla teräviä reunoja, jotka voivat aiheuttaa naarmuja tai haavoja.*
- » *Varmista, että kasvihuone kiinnitetään hyvin jalustaan ja perustukseen, jotta se ei pääse liiukkumaan voimakkaassa tuulessa.*
- » *Älä kiipeä kasvihuoneen katolle. Romahdusvaara.*

- › *Kasvihuone on vakaa vain, kun se on koottu tasaiselle ja vakaalle perustalle ja siten, että kaikki kulmat ovat alkuperäisen suunnitelman mukaiset. Seinien kallistumista aiheuttavat puutteet tai virheet voivat aiheuttaa epävakautta ja johtaa lasipaneelien irtoamiseen tai muihin rakenteellisiin ongelmiin.*

TAKUUEHDOT

Kasvihuoneen 10 vuoden takuu kattaa materiaali- ja valmistusvirheestä johtuvien viallisten osien vaihdon. Takuu alkaa kuitissa ilmoitetusta ostopäivästä, joka on säilytettävä takuun ajan. Takuu kattaa rungon sekä rungon kokoamiseen tarvittavat osat ja tarvikkeet. Takuu ei kata lasilevyjen vaurioita. Takuu ei kata kasvihuoneen kuljetuksessa tai kokoonpanossa tapahtuneita vahinkoja. Takuu ei myöskään kata äärimmäisten sääolosuhteiden tai liiallisen lumikuorman aiheuttamia vaurioita. Kasvihuone on koottava näiden ohjeiden mukaisesti, muuten takuu ei ole voimassa.

TALVISUOJAUS

Green Land Galea on rakennettu runkopaksuudella, joka on vahvempi kuin useimmilla markkinoilla olevilla kilpailevilla tuotteilla. Suosittelemme silti, että suojaat kasvihuoneen hyvin, jotta se pysyy hyvässä kunnossa talven yli. Huomioi alla olevat ehdotukset siitä, miten pidät kasvihuoneesi ehjänä talven yli.

- › *Poista lumikuormat katolta säännöllisesti ja aina runsaan lumisateen jälkeen. Yli 10 cm:n paksuiset lumikuormat voivat olla vaarallisia märän lumen suuren painon vuoksi.*
- › *Tue kasvihuoneen katon harjan keskiosa tukipilarilla.*
- › *Asenna kasvihuone sellaiseen paikkaan, jossa puista tai muista rakenteista ei pääse putoamaan siihen raskaita lumikuormia.*

HUOLTO

Green Land Galea -kasvihuoneiden laatua valvotaan tiukasti, ja odotamme, että saat virheettömän tuotteen. Huomioi alla olevat huolto-ohjeet, jotta kasvihuone pysyy hyvässä kunnossa.

- › *Kaikki saranat ja liukuovien kiskot on voideltava säännöllisesti, jotta ne toimivat moitteettomasti.*
- › *Puhdista kourut lehdistä ja muista roskista säännöllisesti.*
- › *Estä tuulivahingot sulkemalla tuuletusaukot ja ovi kovan tuulen ajaksi.*
- › *Voit puhdistaa rungon pinnat miedolla pesuaineella. Älä käytä hankaavia pesuaineita.*
- › *Voit puhdistaa lasipinnat ikkunanpesuaineella.*
- › *Puhdista kasvihuone perusteellisesti sekä ennen kasvukautta että sen jälkeen.*



Kasvihuoneen kokoaminen

Tutustu hyvin ohjeisiin ja tarvittaviin lisävarusteisiin ennen kuin aloitat kasvihuoneen kokoamisen. Ohjeet on esitetty tekstin ja kuvien yhdistelmänä. Kokoa kasvihuoneen runko osa kerrallaan. Kaikkien osien pultit ja erilaiset liitososat löytyvät yhdestä pakkauksesta yhdessä tämän käyttöohjeen kanssa.

Kukin pakkaus on eritelty osaluettelossa. Kaikki yksityiskohtaiset kuvat on merkitty symbolilla:



SISÄLTÄ KATSOTTUNA



ULKOA KATSOTTUNA

OSA 1 – PERUSTA

Kasvihuone toimitetaan korkealaatuisen alumiinisokkelin kanssa, ja on suositeltavaa, että kasvihuone kootaan tätä jalustaa käyttäen. Kasvihuoneen perustuksen voi tehdä monin eri tavoin. Tässä oppaassa esitellään kaksi suosittua tapaa, joissa molemmissa käytetään kasvihuoneen mukana toimitettua alumiinista sokkeliä. Asenna kasvihuone joko nurmikolle tai maahan käyttämällä mukana toimitettua alumiinisokkeliä tai asenna se tukevalle betoniperustukselle. Betoniperustus voidaan valaa joko koko kasvihuoneen alle, jolloin kasvihuoneelle tehdään betonilattia, tai perustus voidaan rakentaa vain kasvihuoneen seinien alle. Betonille asennettaessa alumiinisokkelin käyttö on valinnaisista, mutta suositeltavaa. Jäljempänä olevat asennusohjeet koskevat asennusta sokkeliä käyttäen

SOKKELIN OSALUETTELO

- » **ALUMIINIPIFIILI 203,8 CM X 2 KPL**
- » **ALUMIINIPIFIILI 349,4 CM X 2 KPL**
- » **ANKKURIJALAT X 6 KPL**
- » **KIINNITYSKIELEKKEET X 12 KPL**
- » **M6-PULTIT X 20 KPL**
- » **M6-PULTIT, JOISSA ON KATKAISTU PÄÄ X 12 KPL**
- » **M6-MUTTERIT X 32 KPL**
- » **ALUSLEVYIT X 8 KPL**

VAIHTOEHTOA 1 KOSKEVAT OHJEET:

Asennus nurmikolle tai maahan alumiinisokkelin avulla

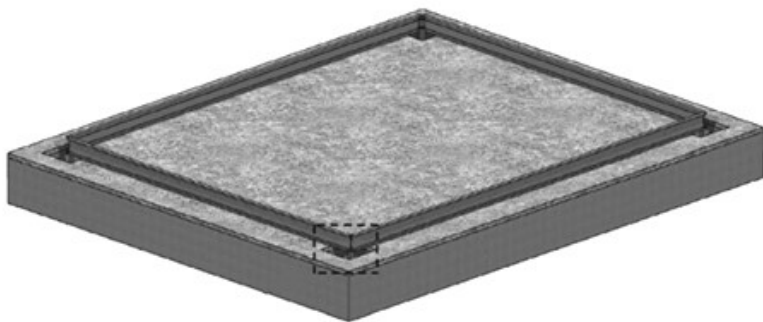

Lue asennusvaiheet huolellisesti läpi ennen asennuksen aloittamista ja varmista, että sinulla on kaikki tarvittavat työkalut, tarvikkeet ja materiaalit käsillä.

KOKOAMISVAIHEET

- 1. Asenna ankkurijalat perustuksen kulmiin ja pitkien sivujen keskelle. Kun asennat ankkurijalkoja betoniin, taivuta kulmajalkojen alaosa paremman kiinnityksen varmistamiseksi.*
- 2. Kaiva maahan noin 80 cm:n syvyiset reiät niihin paikkoihin, joihin ankkuri jalkojen on tarkoitus mennä, jotta perustus menee routasyvyyden alapuolelle. Aseta halkaisijaltaan noin 200 mm:n putket betonია varten reikiin ja täytä ne betonilla.*
- 3. Paina ankkurijalat betoniin. Perustuksen on oltava täysin tasainen ja sokkelin kulmien on oltava täsmälleen 90 asteen kulmassa. Voit mitata diagonaalimitat ja varmistaa, että ne ovat yhtä suuret, jolloin kulmat ovat oikein.*
- 4. Sokkelin ja betonin välisen etäisyyden on oltava noin 5 mm. Voit käyttää 5 mm:n paksuista esinettä tämän varmistamiseksi.*
- 5. Anna betonin kuivua kokonaan.*
- 6. Perustus on valmis, ja voit aloittaa kasvihuoneen kokoamisen sokkelille.*

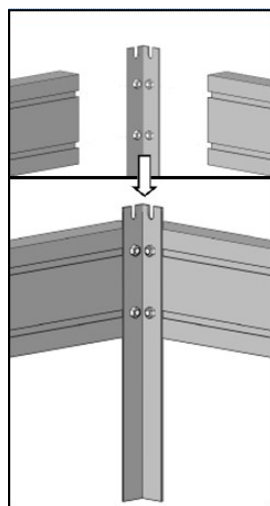

VAIHTOEHTOA 2 KOSKEVAT OHJEET: Asennus betoniperustalle alumiinisokkelin avulla

Lue asennusvaiheet huolellisesti läpi ennen asennuksen aloittamista ja varmista, että sinulla on kaikki tarvittavat työkalut, tarvikkeet ja materiaalit käsillä.

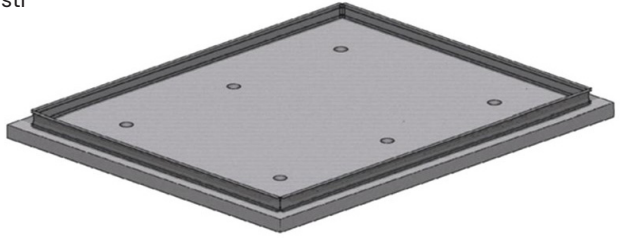

KOKOAMISVAIHEET

- 1. Rakenna joko betonilattia, joka on suurempi kuin kasvihuoneen ulkomitta, tai betoniperustus, joka menee kasvihuoneen seinien alle, mutta ei kata kasvihuoneen lattia-alueita. Jos rakennat perustuksen vain seinien alle, varmista, että perustuksen leveys on vähintään 10 cm (suositeltava leveys 30 cm) ja korkeus vähintään 30 cm (suositeltava korkeus 50 cm).*
- 2. Varmista, että perustus on täysin tasainen ja kuiva ennen alumiinisokkelin asentamista.*
- 3. Ankkurijalat on lyhennettävä sopivaan pituuteen esimerkiksi rautasahalla. Kohdista ankkurijalkojen ja sokkelin reiät ja lyhennä niitä siten, että ankkurijalkoja katkaistaan sokkelin alaosan mukaisesti. Oikein tehtynä ankkurijalkojen pituus on noin 19,5–20 cm.*
- 4. Alumiinisokkeliin ja betoniperustukseen on porattava reiät, ja sokkelin kiinnittämiseen perustukseen on käytettävä sopivia ruuveja ja ankkureita. Huomaa, että alumiinisokkelin muodon vuoksi poraaminen ja ruuvaaminen on tehtävä pienessä kulmassa. On suositeltavaa, että sokkeli kiinnitetään perustukseen 14 kohdasta (2 ruuvia jokaiseen kulmaan, 2 ruuvia molemmille pitkille sivuille ja 1 ruuvi molemmille lyhyille sivuille). Ota yhteyttä paikalliseen rautakauppaan sopivien ruuvien ja ankkuritulppien hankkimiseksi.*
- 5. Perustus on valmis, ja voit aloittaa kasvihuoneen kokoamisen sokkelille.*

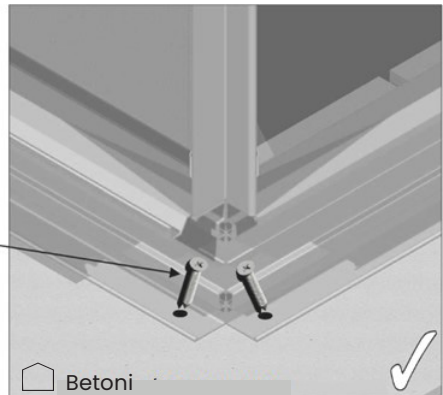
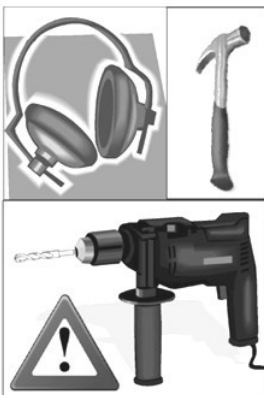

OSA II – KASVIHUONE

Rakenna ensin kasvihuoneen runko valmiiksi alla olevien kuvien ohjeiden mukaisesti. Kiinnitä sitten runko alumiinisokkeliin tai suoraan betoniperustukseen ennen lasien asentamista runkoon.

RUNGON ASENTAMINEN PERUSTUKSEEN

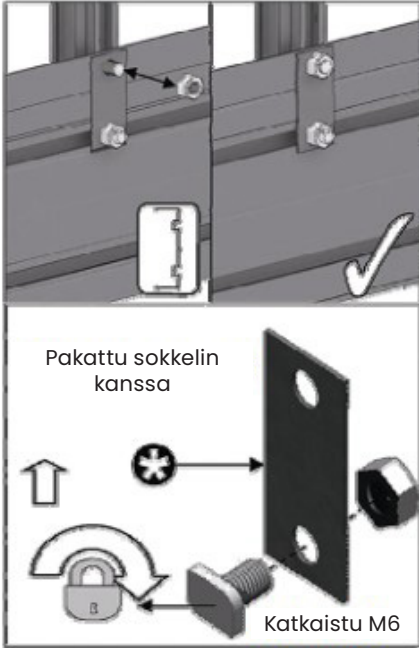

	
#	m7
—	12

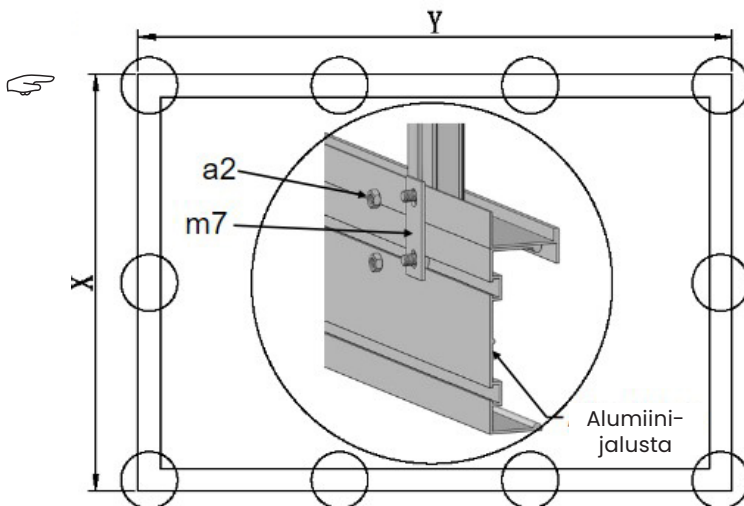

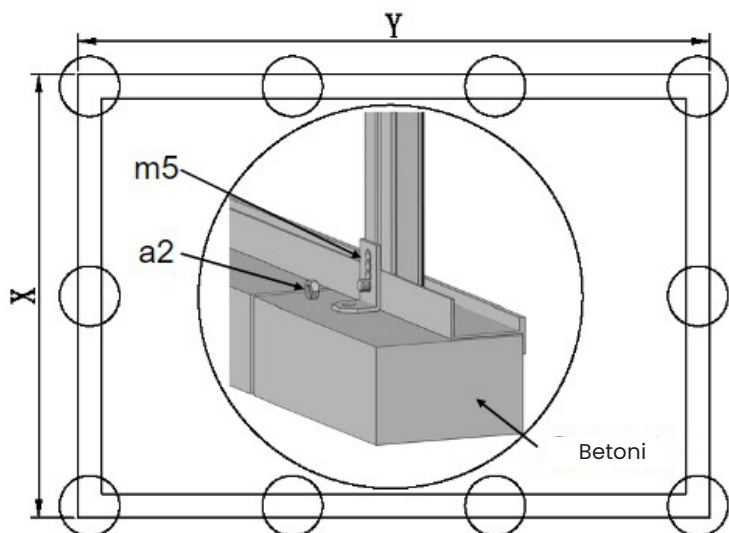

	
#	m5
—	16

	X	Y
—	2098	3554

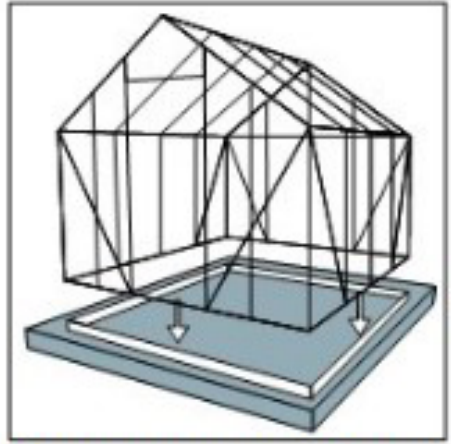

Kiinnitä kasvihuone perustukseen

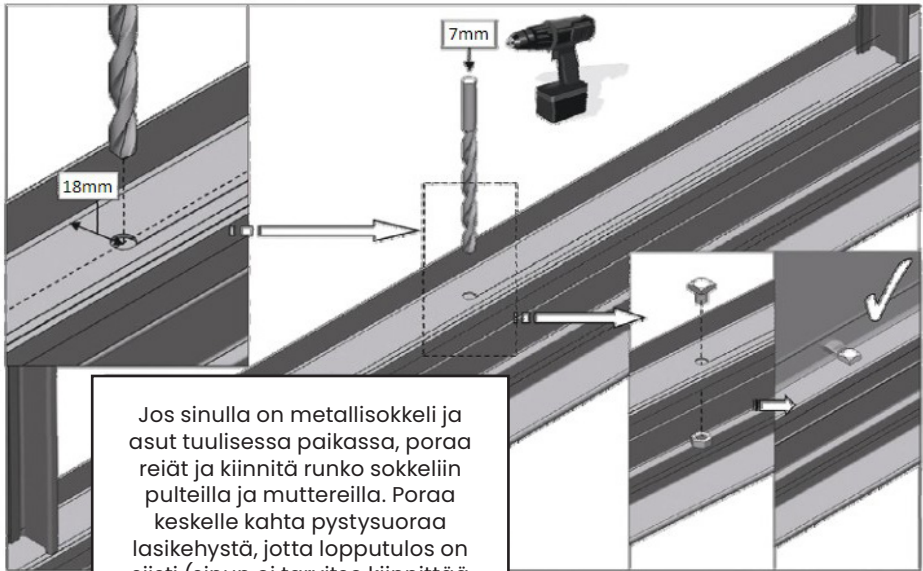

Jos sinulla on metallisokkeli ja asut tuulisessa paikassa, poraa reiät ja kiinnitä runko sokkeliin pulteilla ja muttereilla. Poraa keskelle kahta pystysuoraa lasikehystä, jotta lopputulos on siisti (sinun ei tarvitse kiinnittää jokaisesta kehyksestä). Varmista, ettei pultin pää osu lasiin.
Poraa reiät 18 mm:n päähän ulkoreunasta, jotta pultti ei osu lasiin. Älä ankkuroi rakennetta maahan ennen kuin kokoaminen on suoritettu loppuun.

1															
#	612	622	641	655	656	663	664	711	712	a1	a2	a9	a14	m1	m2
Size	2038	656	1415	1198	1198	1889	1889	1526	710	M6x10	M6	M4	M4x16	-	-
QTY	1	1	2	1	1	1	1	2	2	22	22	1	1	1	2

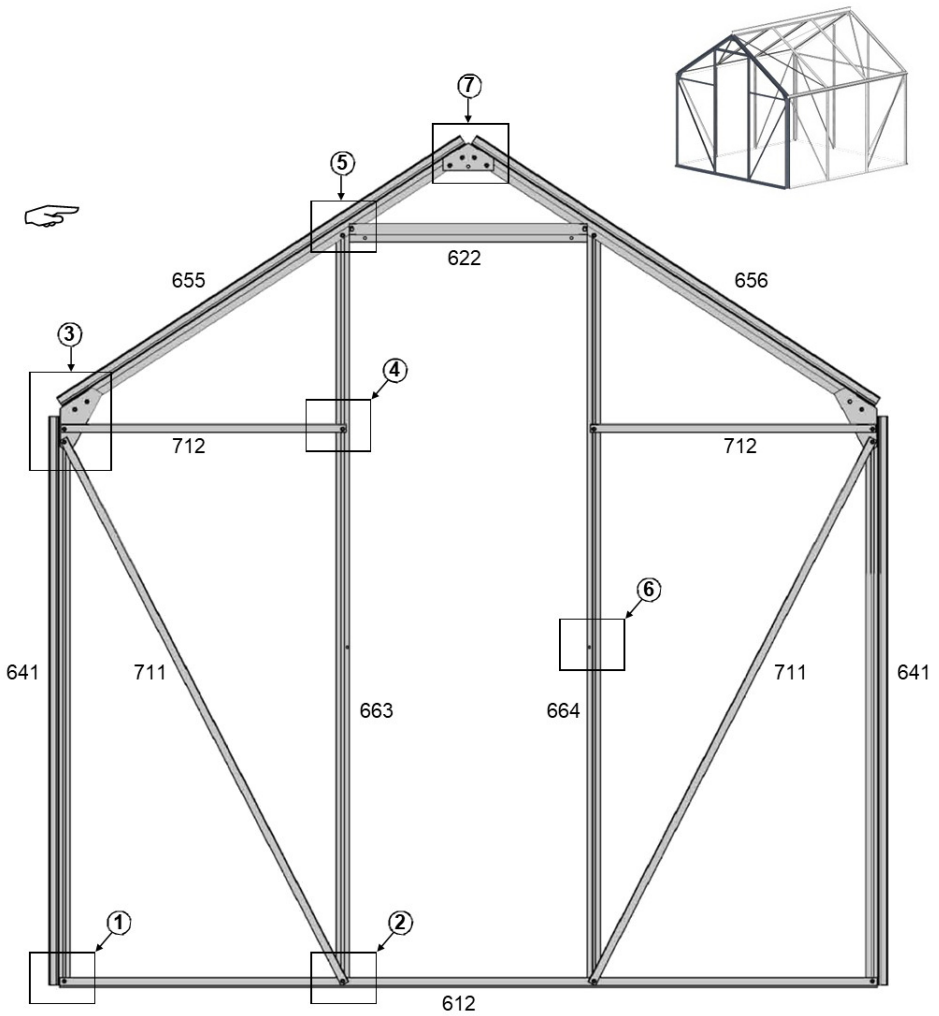

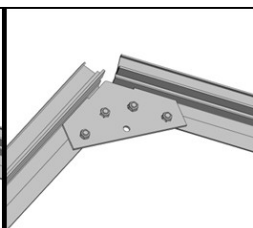
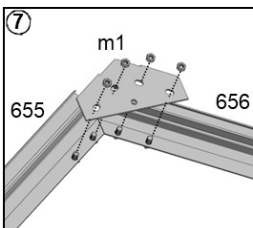
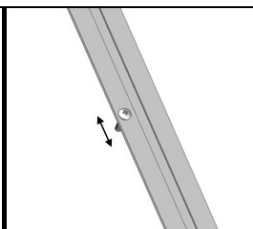
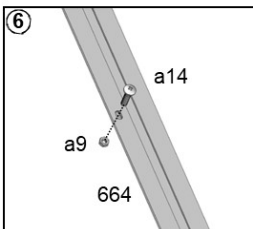
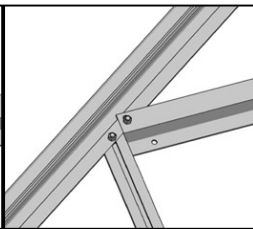
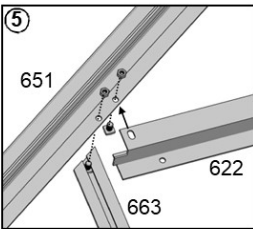
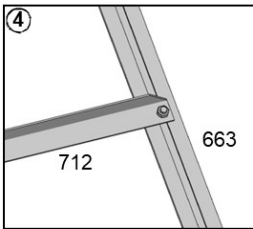
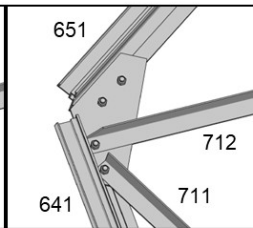
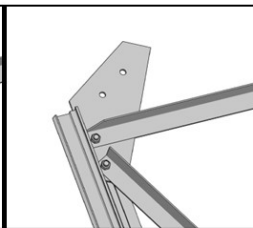
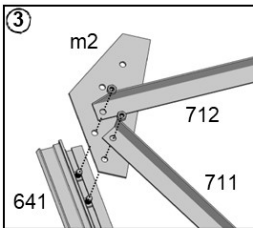
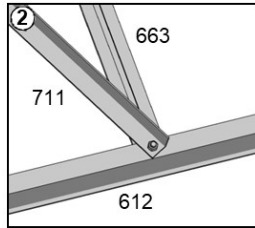
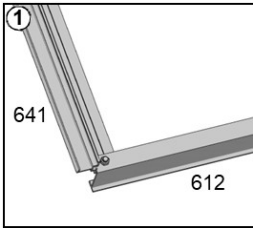

2												
#	633	641	657	658	663	664	782	711	a1	a2	m1	m2
Size	2038	1415	1198	1198	1889	1889	2036	1526	M6x10	M6	-	-
QTY	1	2	1	1	1	1	1	2	20	20	1	2

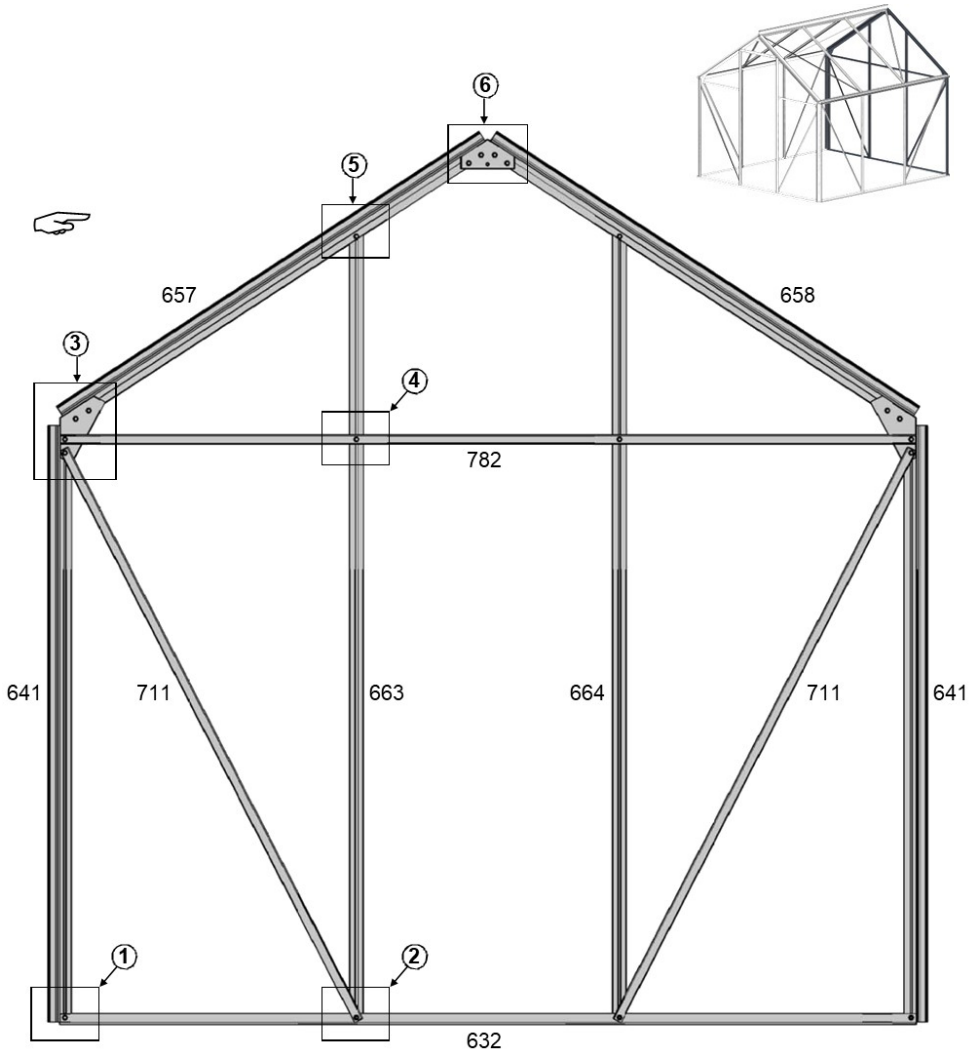

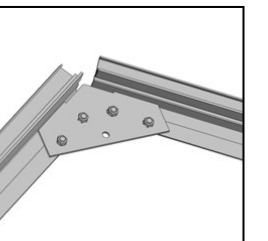
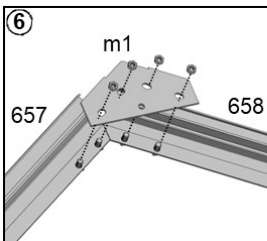
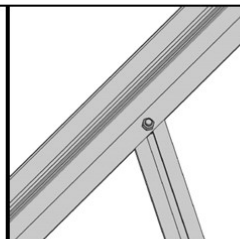
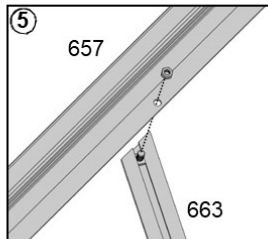
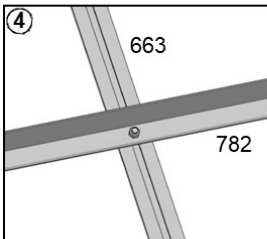
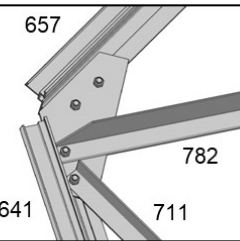
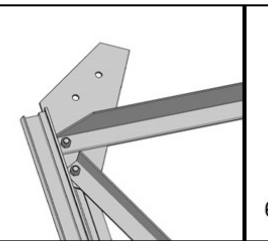
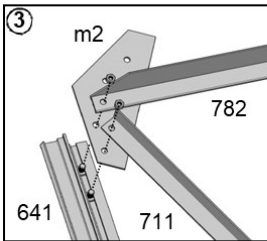
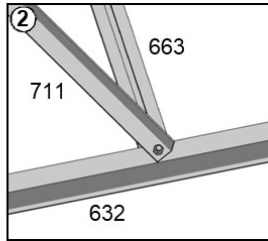
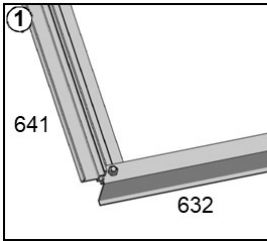



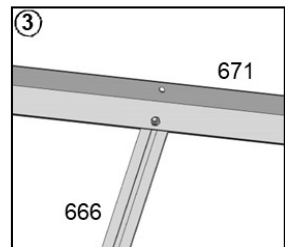
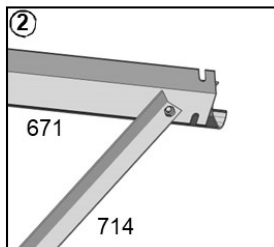
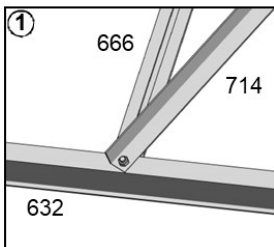
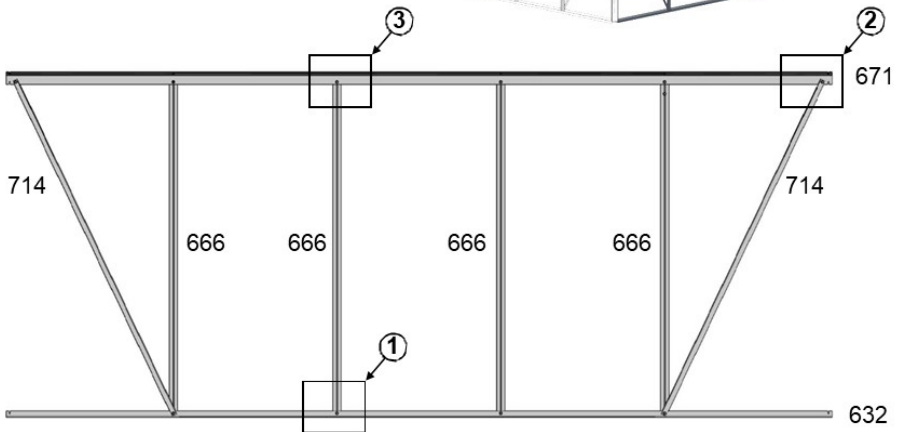
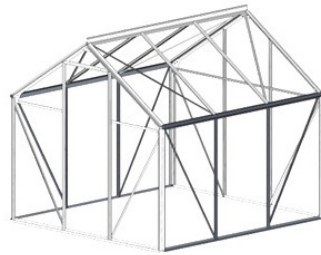

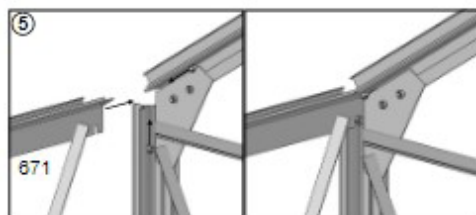
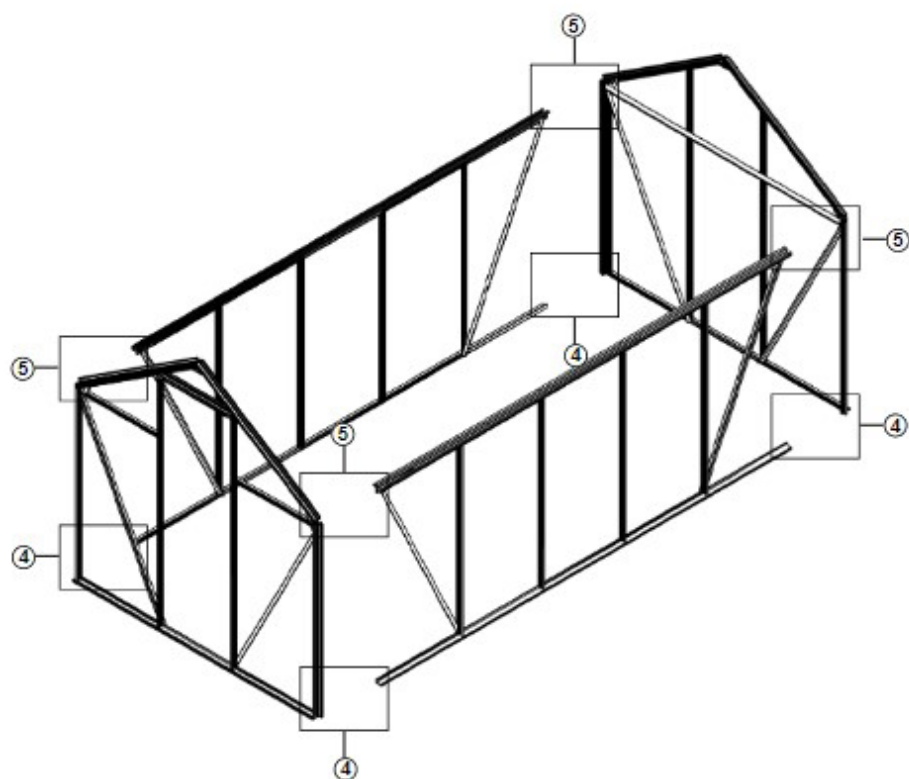

3														
#	632					666	671					714	a1	a2
Size	1414	2108	2802	3496	4190	1415	1414	2108	2802	3496	4190	1565	M6x10	M6
—				2		8				2		4	28	28





4											
#	701					682	715	751	a1	a2	B-p1
Size	1414	2108	2802	3496	4190	1198	1375	400	M6x10	M6	-
				1		8	4	4	36	36	2

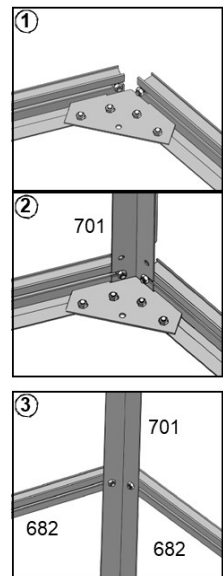
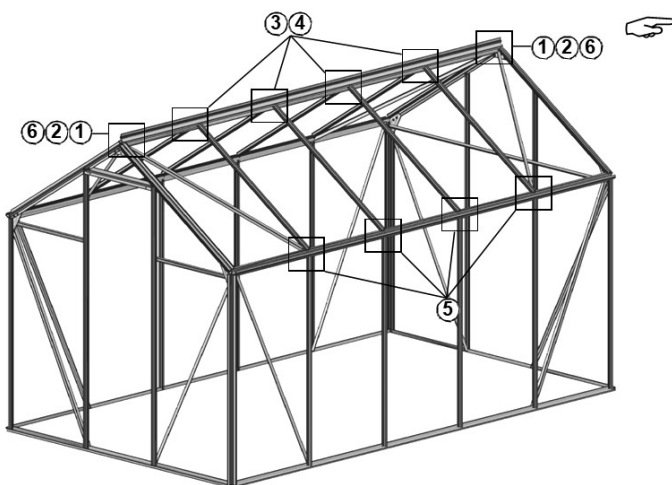

③④ Huomaa: Lisää valmiiksi toinen pultti kattoharjan kanavaan tai ikkunaan varten.

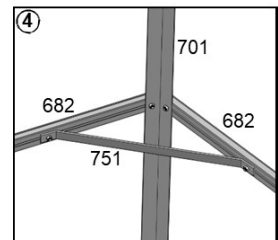
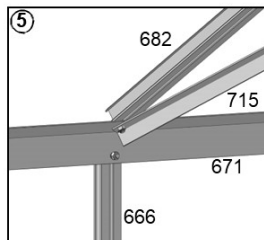
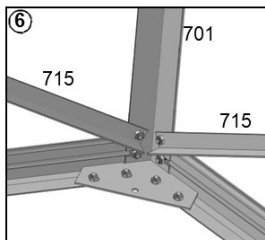

Lasi

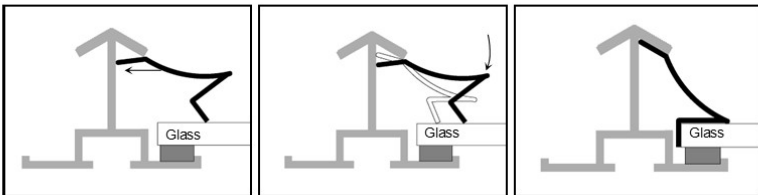
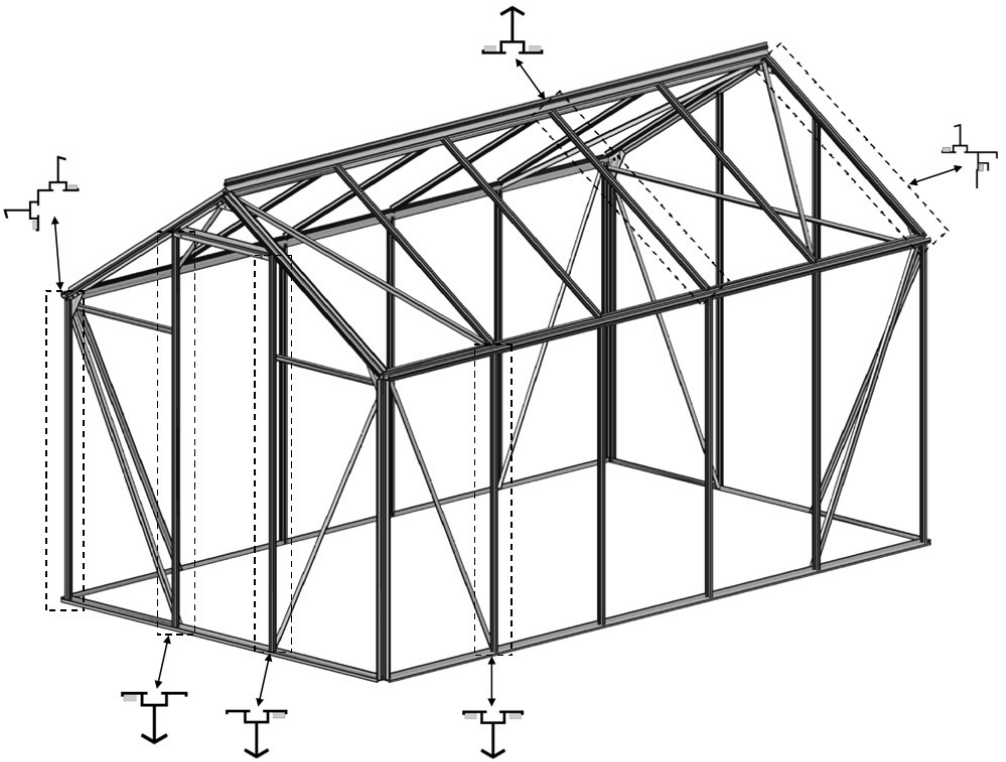
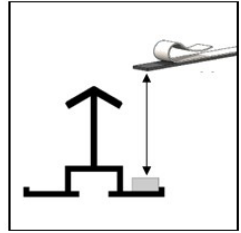

Lasi

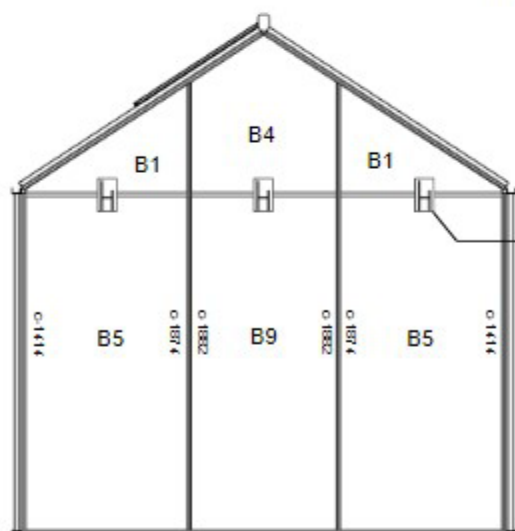
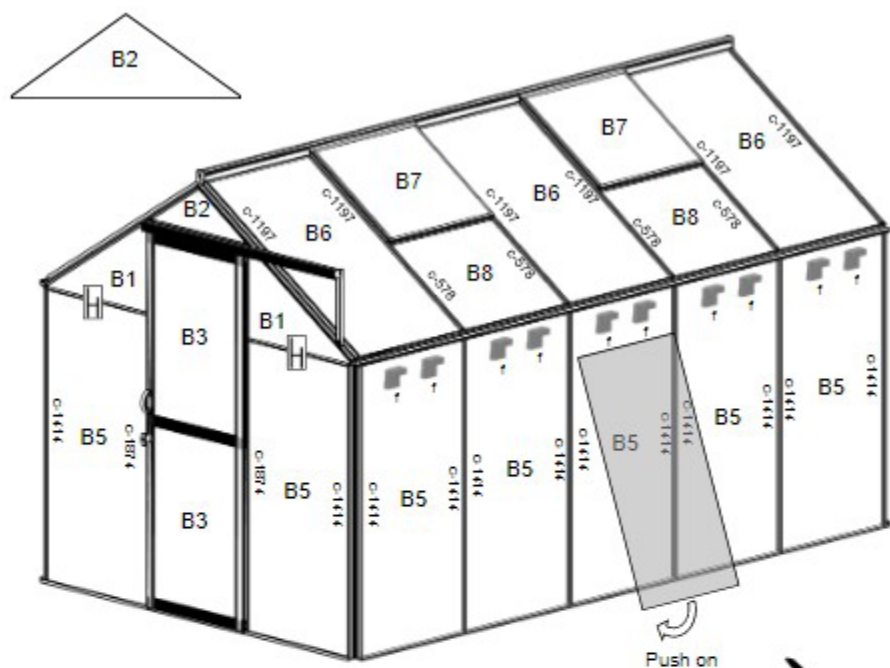





If you feel PVC size not correct, please use scissors to cut it.



Lasi

#	mm	
B1	677 x 23 / 462	4
B2	609 x 18 / 215 / 18	1
B3	572 x 843	2
B4	609 x 474 / 671 / 474	1
B5	677 x 1412	14
B6	677 x 1203	6
B7	677 x 624	4
B8	677 x 585	4
B9	609 x 1412	1
H	660	4
	592	1
	5 meter	15 roll

		DWG	Length				DWG	Length	
Front Gable	c		1414	2	Rear Gable	c		1414	2
			1874	2				1874	2
Roof	c		578	8	Side wall	c		1414	20
			1197	12				f	

5													
#	571	581	582	583	591	592	791	594	384	p4	p5	m10	n1
Size	1265	623	633	633	1822	1822	359	830	-	-	-	-	-
QTY	1	1	1	1	1	1	1	4	1	2	2	2	4

#	a1	a2	a5	a6	a9	a11
Size	M6x10	M6	Φ3.5x19	Φ3.5x25	M4	M4x25
QTY	8	8	12	4	2	2

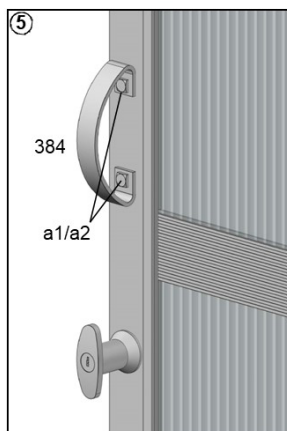
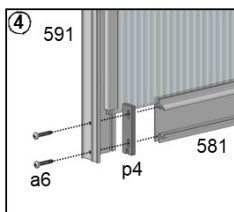
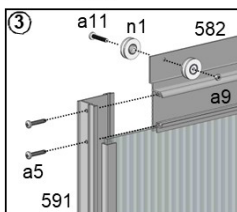
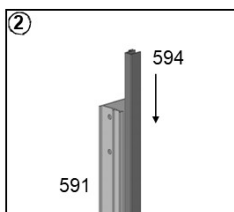
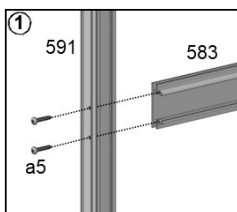
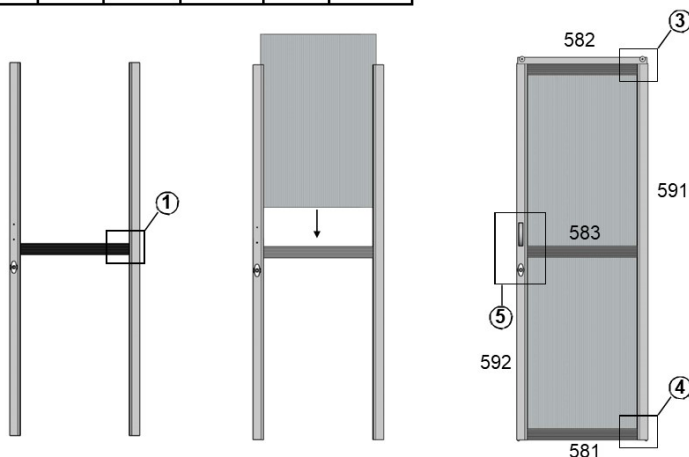

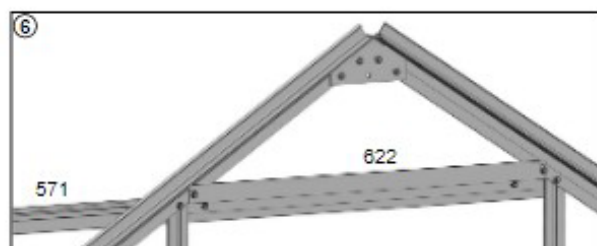
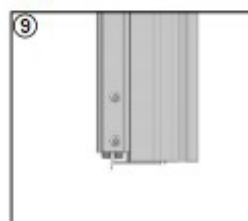
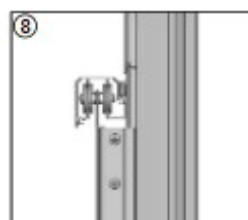
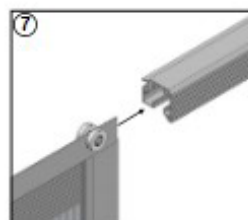
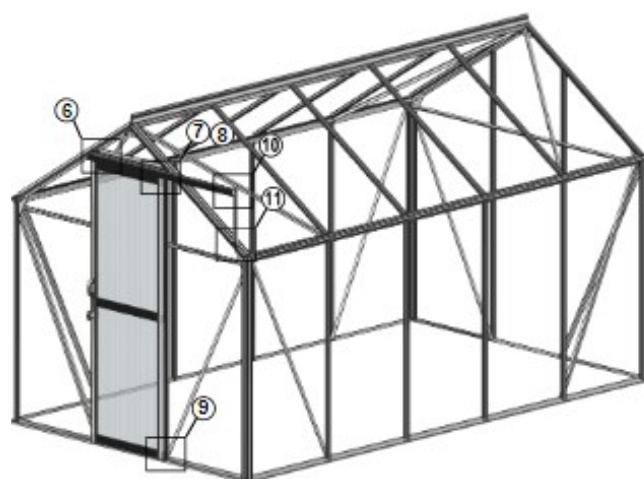

Section View

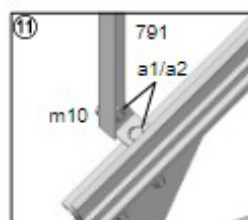
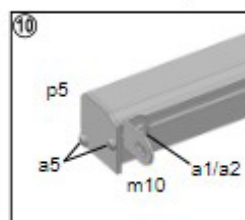
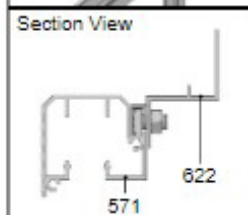

6												
#	521	541	531	551	201	a1	a2	a4	a7	a9	p3	p10
Size	724	695	601	678	300	M6x10	M6	Φ3.9x8	M4x8	M4	-	-
QTY	1	1	2	1	1	8	8	2	2	2	2	1

Vent No.	4
----------	---

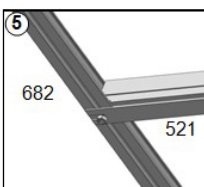
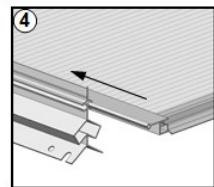
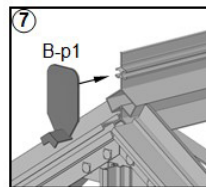
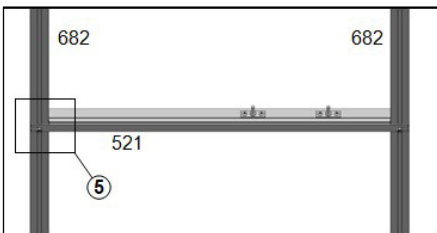
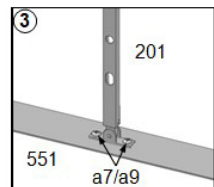
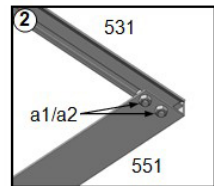
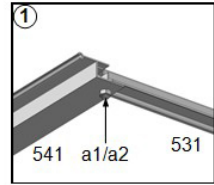
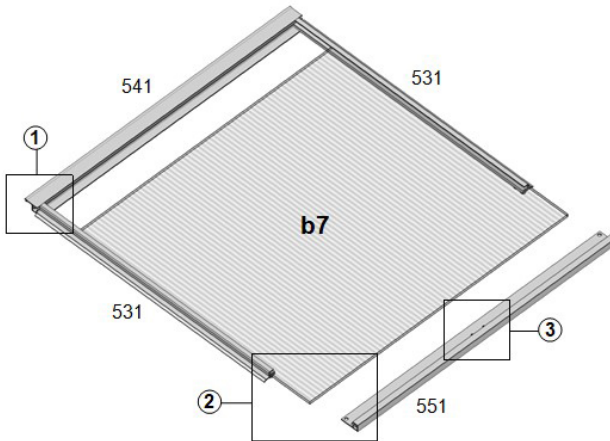

Muovista osaa P3 käytetään ikkunan kummallakin puolella, jotta se ei pääse liikkumaan sivusuunnassa. Ruuvi 34 laajentaa muoviosaa ja pitää ikkunan tukevasti paikallaan.

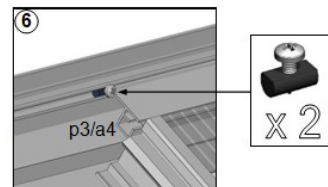

Aseta muoviosa P3 kattoharjan kanavaan ennen kattopaneelin asennusta, jotta ikkuna on tukevasti paikallaan.

Röystässetti

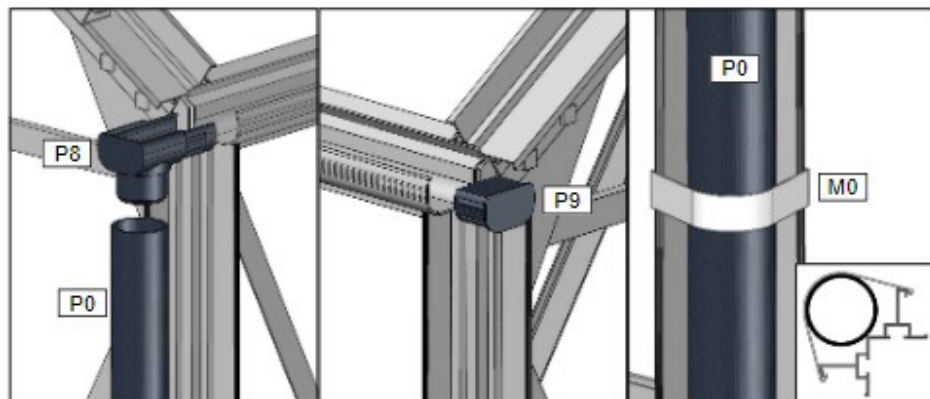
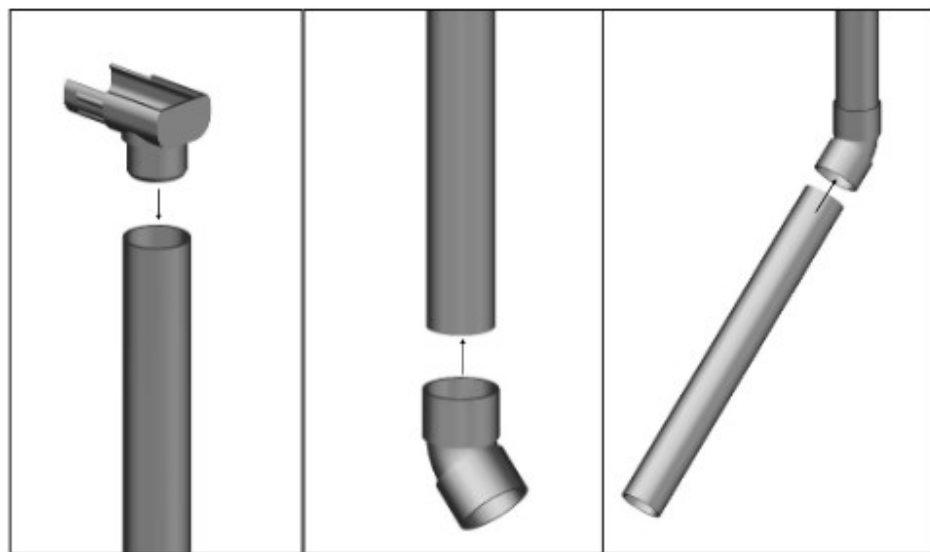

#	P8	P9	M0	P1	P0	P2
mm					800	200
QTY	2	2	2	2	2	2

Congratulations on your purchase of your new Green Land Galea greenhouse. We hope the greenhouse will bring you pleasure of gardening and feelings of happiness when growing your plants or vegetables.

Please read below assembly instructions carefully before starting the assembly, and also make sure you have all the parts listed on the parts list together with all the tools required for the assembly. Keep the instruction manual stored for later use.

TECHNICAL DETAILS

- » **WIDTH: 212,5 CM**
- » **LENGTH: 354,3 CM**
- » **HEIGHT (WITH BASE): 140/219,5 CM**
- » **WEIGHT: 245 KG**
- » **AREA: 7,53 M²**
- » **FRAME COLOR: BLACK**
- » **FRAME MATERIAL: ALUMINUM**
- » **FRAME THICKNESS: 1,3-3,0 MM**
- » **ROOF AND WALL PANELS: 3 MM TEMPERED SAFETY GLASS**
- » **BASE: 10 CM HIGH ALUMINUM BASE**
- » **VENTS: 2PCS OF MANUALLY OPENED ROOF VENTS**
- » **DOOR: LOCKABLE SLIDING DOOR**
- » **WARRANTY: 10 YEARS FOR THE FRAME**

WARNINGS AND NOTIFICATIONS

- *Familiarize yourself with the local laws and regulations before assembling the greenhouse.*
- *Find a level and stable location for the greenhouse. If the ground or foundation is not level, do not install the greenhouse. Always first make sure to level the foundation.*
- *Only assemble the greenhouse in good weather conditions. Do not assemble when there are heavy winds.*
- *It is recommended that at least 2-3 people are present when assembling the greenhouse.*
- *Please note that the greenhouse is built out of many parts and accessories and the assembly takes time.*
- *Choose a location where you have enough space to work around the greenhouse.*
- *Use protective gloves and long sleeved shirts when assembling the greenhouse. There might be sharp edges, which can cause scratches or wounds.*

- › *Always make sure to attach the greenhouse well into the base and foundation to prevent it from moving under heavy winds.*
- › *Do not climb onto the greenhouse roof. Danger of collapsing.*
- › *The greenhouse can only be stable when it is on a level and solid foundation and assembled in a way that it is fully level and all angles are as they are originally intended. Any flaws or mistakes causing the walls to be tilted might cause the structure to become unstable and result in glass panels to get detached or in other structural failure.*

WARRANTY TERMS

The 10 year warranty of this greenhouse covers the replacement of defective parts due to material or manufacturing fault. The warranty period starts from the purchase date shown on the receipt, which should be kept stored throughout the warranty period. The warranty covers the frame and the parts and accessories used to assemble the frame together. Warranty does not cover damage to the glass sheets. Warranty does not cover damage occurring in transportation or assembly of the greenhouse. Warranty also does not cover damage caused by extreme weather conditions or excessive snow loads. The greenhouse must be assembled according to these instructions or the warranty will not be valid.

WINTER PROTECTION

Green Land Galea is constructed with frame thickness, which is stronger than most competing products on the market. We still recommend you to protect your greenhouse well for it to stay in good condition over the winter. Pay attention to below suggestions on how to keep your greenhouse intact over winter.

- › *Remove snow loads from the roof regularly and always after heavy snowfall. Snow loads in excess of 10 cm in thickness are potentially dangerous due to the heavy weight of wet snow.*
- › *Support the roof ridge at the center of the greenhouse by a support pillar.*
- › *Install the greenhouse at a location where heavy snow loads cannot fall on it from trees or other structures.*

MAINTENANCE

Quality of Green Land Galea greenhouses is controlled strictly and we expect you to receive faultless products. Please pay attention to below maintenance instructions to keep the greenhouse in good condition.

- › *All hinges and sliding door tracks should be greased regularly to allow smooth operation.*
- › *Clean the gutters from leaves and other trash regularly.*
- › *Prevent wind damage by closing the vents and the door on heavy winds.*
- › *You can clean the frame surfaces by using mild household detergent. Do not use abrasive detergents.*
- › *You can clean the glass surfaces by using window cleaning solution.*
- › *Clean the greenhouse thoroughly both before and after the growing season.*

Please familiarize yourself well with the instructions and required accessories before you start assembling the greenhouse. The instructions are provided as a combination of text and illustrations. Assemble the greenhouse frame one section at a time. Bolts and various fittings for all sections will be found in one package together with this instruction manual.

Each package is specified in the parts list. All detailed illustrations are marked with a symbol:



SEEN FROM INSIDE



SEEN FROM OUTSIDE

PART 1 – THE FOUNDATION

This greenhouse is delivered with high quality aluminum base included, and it is recommended that the greenhouse is installed by using this base. There are multiple ways of making the foundations for the greenhouse. In this manual we show two popular ways which both use the aluminum base delivered with the greenhouse. Either install the greenhouse on grass or ground using the aluminum base included or install it on a solid concrete foundation. Concrete foundation can either include the concrete floor to the greenhouse or just be built under the greenhouse walls. When installing on concrete the usage of the aluminum base is optional but recommended. The installation instructions below refer to installation with the aluminum base.

BASE PARTS LIST

- » **ALUMINUM PROFILE 203,8 CM X 2PCS**
- » **ALUMINUM PROFILE 349,4 CM X 2PCS**
- » **ANCHOR LEGS X 6PCS**
- » **FIXING TABS X 12PCS**
- » **M6 BOLTS X 20PCS**
- » **M6 BOLTS WITH CROPPED HEAD X 12PCS**
- » **M6 NUTS X 32PCS**
- » **WASHERS X 8PCS**

INSTRUCTIONS FOR OPTION 1: Assembly on grass or ground using the aluminum base

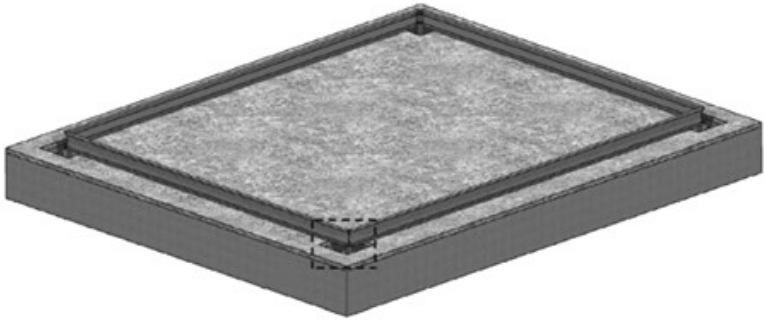

Please read through the assembly steps thoroughly before starting the installation process, and make sure you have all the necessary tools, accessories and materials at hand.
Assembly steps

1. *Install the anchor legs in the corners and middle of the long sides of the foundation. When installing the anchor legs into concrete you should bend the bottom parts of the corner legs for securing better attachment.*
2. *Dig approximately 80 cm deep holes on the ground in the places where the anchor legs should go to make the foundation go below freezing depth. Install approximately 200 mm diameter pipes (not included) for concrete in the holes and fill up with concrete.*
3. *Press down the anchor legs in the concrete. The foundation has to be totally level and the corners must be exactly in 90° angle. You can measure the diagonal measurements of the foundation and make sure they are equal to confirm that the angles are correct.*
4. *The spacing between the base and the concrete pipes should be approximately 5 mm. You can use a 5 mm thick object to ensure this.*
5. *Let the concrete dry completely.*
6. *The foundation is ready and you can start installing the greenhouse on the base.*

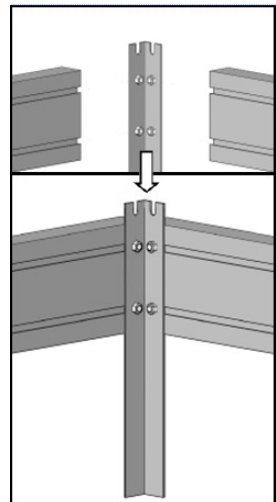

INSTRUCTIONS FOR OPTION 2: Assembly on concrete foundation using the aluminum base

Please read through the assembly steps thoroughly before starting the installation process, and make sure you have all the necessary tools, accessories and materials at hand.

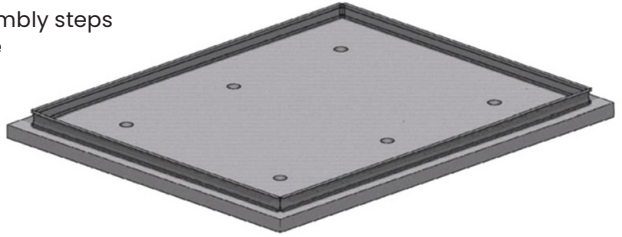

ASSEMBLY STEPS

1. *Build either a concrete floor, which is larger than the greenhouse outer measurement, or a concrete foundation that goes under the walls of the foundation, but leaves the greenhouse floor area open. If building a foundation only under the walls make sure, that the width of the foundation is a minimum of 10 cm (recommended width 30 cm) and height a minimum of 30 cm (recommended height 50 cm).*
2. *Make sure that the foundation is fully level and dry before installing the aluminum base on it.*
3. *The anchor legs must be shortened to a suitable length by using a hacksaw for example. Align the holes on the anchor legs and the base and shorten in a way that the anchor leg is cut to be level with the bottom part of the base. The anchor leg length should be approximately 19,5-20 cm when done correctly.*
4. *You need to drill holes on the aluminum base and the concrete foundation and use suitable screws and anchors to fix the base on the foundation. Please note that due to the shape of the aluminum base the drilling and screwing needs to be done in a small angle. It is recommended that the base is fixed on the foundation in 14 places (2 screws for each corner, 2 for both long sides and 1 for both short sides). Please contact your local hardware store for acquiring suitable screws and anchor plugs.*
5. *The foundation is ready and you can start installing the greenhouse on the base.*

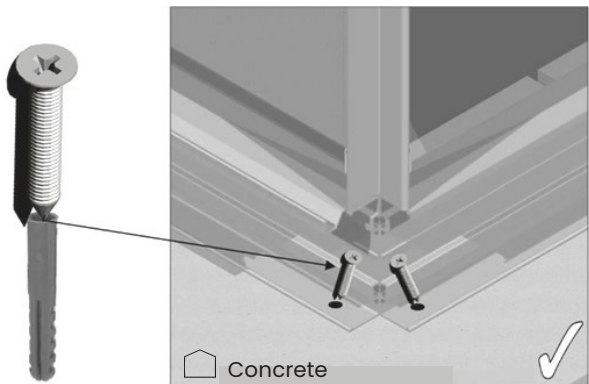
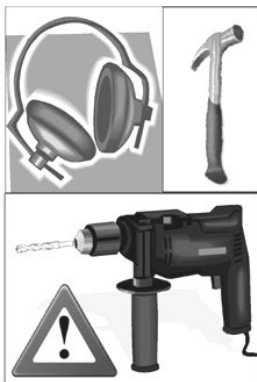

PART II – THE GREENHOUSE

Build the frame of the greenhouse ready first using below instructions. Then attach the frame to the aluminum base or directly to the concrete foundation before installing the glasses on the frame.

INSTALLING THE FRAME ON THE FOUNDATION

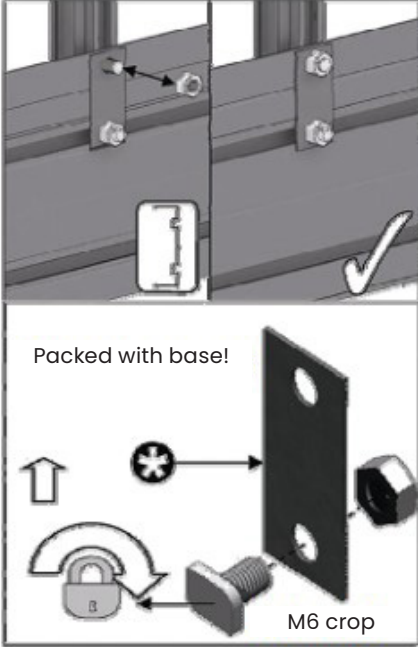

	
#	m7
—	12

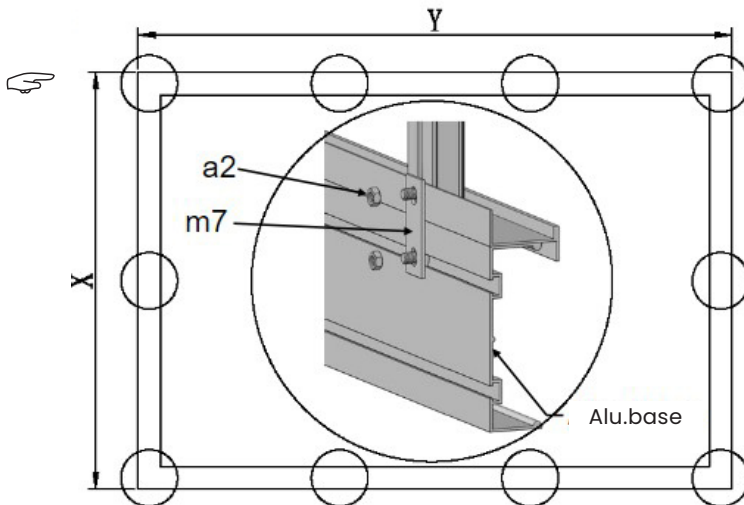

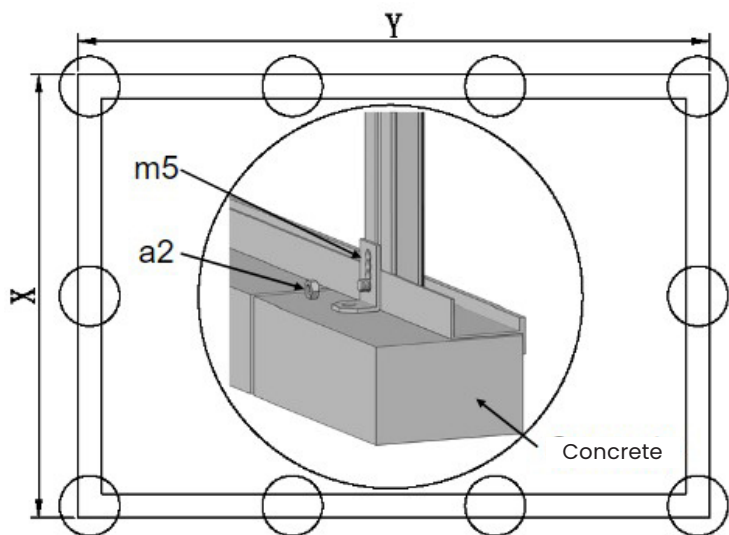

	
#	m5
—	16

	X	Y
—	2098	3554

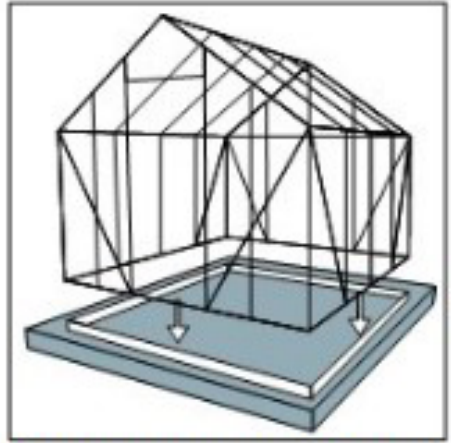
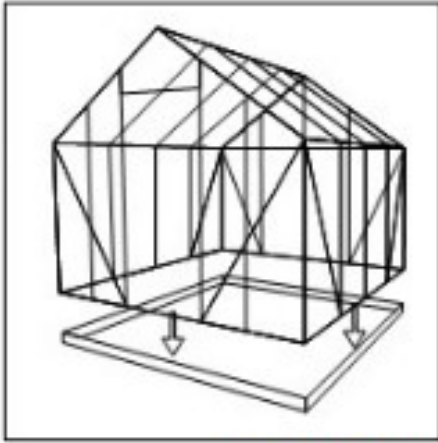

Secure the greenhouse to the foundation

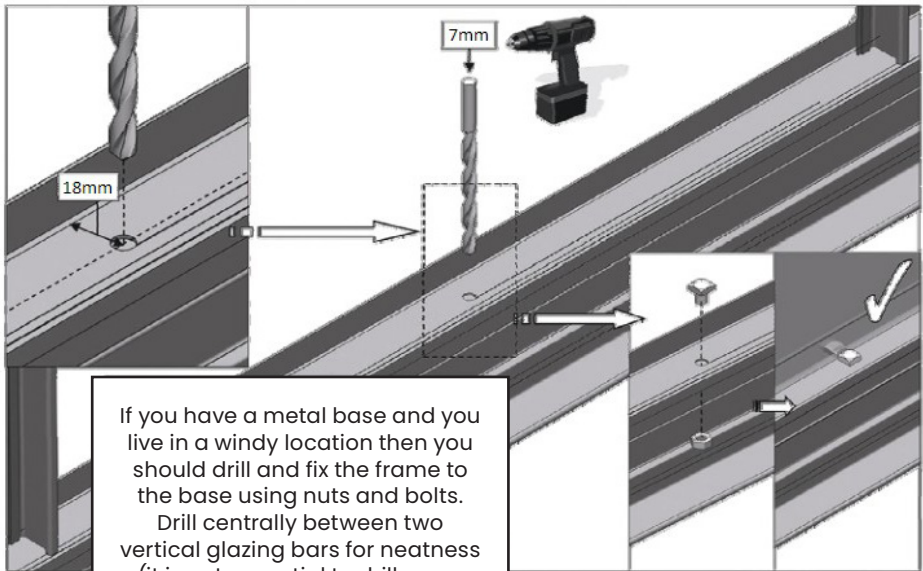

If you have a metal base and you live in a windy location then you should drill and fix the frame to the base using nuts and bolts. Drill centrally between two vertical glazing bars for neatness (it is not essential to drill every section). Make sure the bolt head does NOT interfere with line of the glass. Cills should be drilled 18mm from the inside vertical face to avoid the front glass face. Do NOT anchor the structure to the ground until the end!

Front gable

PACKAGE 1

1															
#	612	622	641	655	656	663	664	711	712	a1	a2	a9	a14	m1	m2
Size	2038	656	1415	1198	1198	1889	1889	1526	710	M6x10	M6	M4	M4x16	-	-
QTY	1	1	2	1	1	1	1	2	2	22	22	1	1	1	2

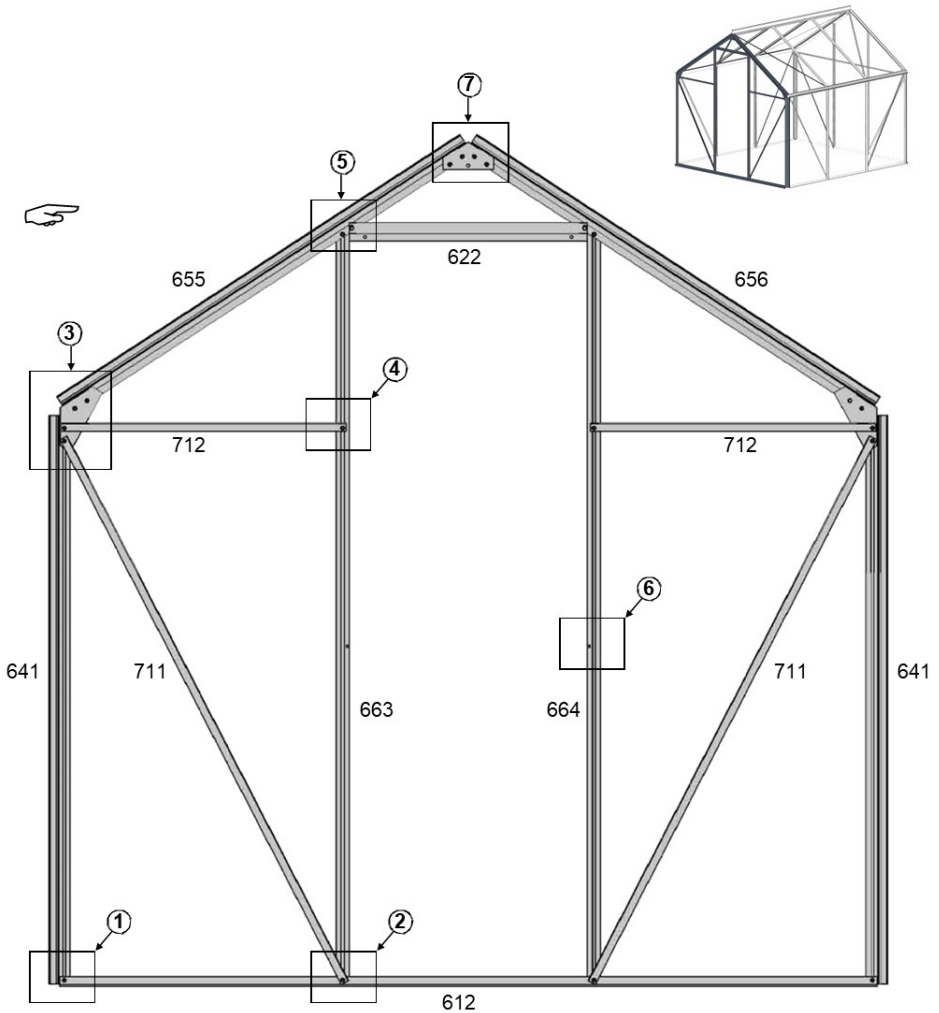

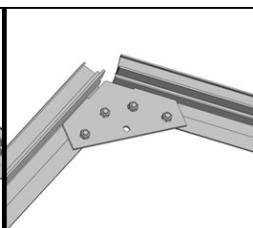
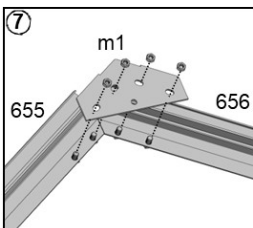
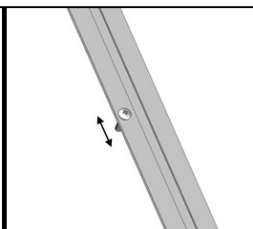
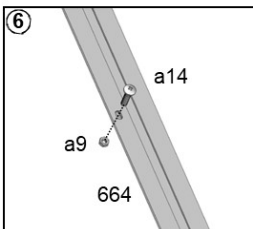
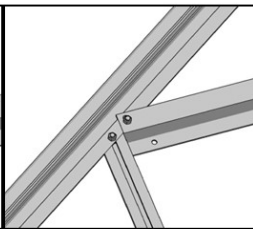
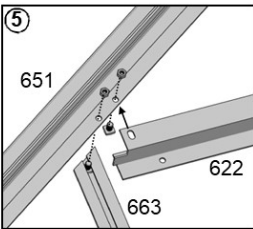
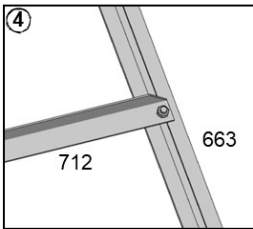
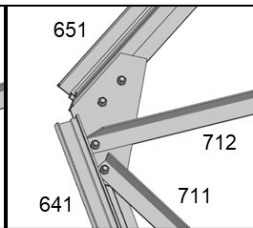
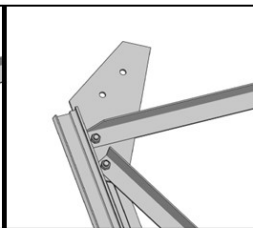
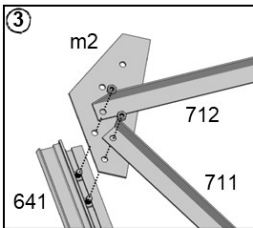
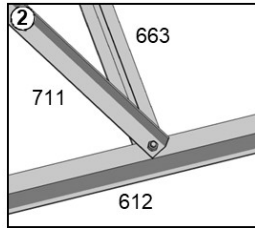
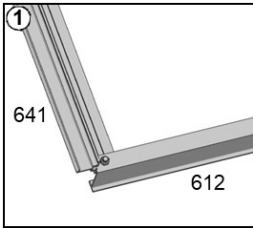

Rear gable

PACKAGE 2

2												
#	633	641	657	658	663	664	782	711	a1	a2	m1	m2
Size	2038	1415	1198	1198	1889	1889	2036	1526	M6x10	M6	-	-
QTY	1	2	1	1	1	1	1	2	20	20	1	2

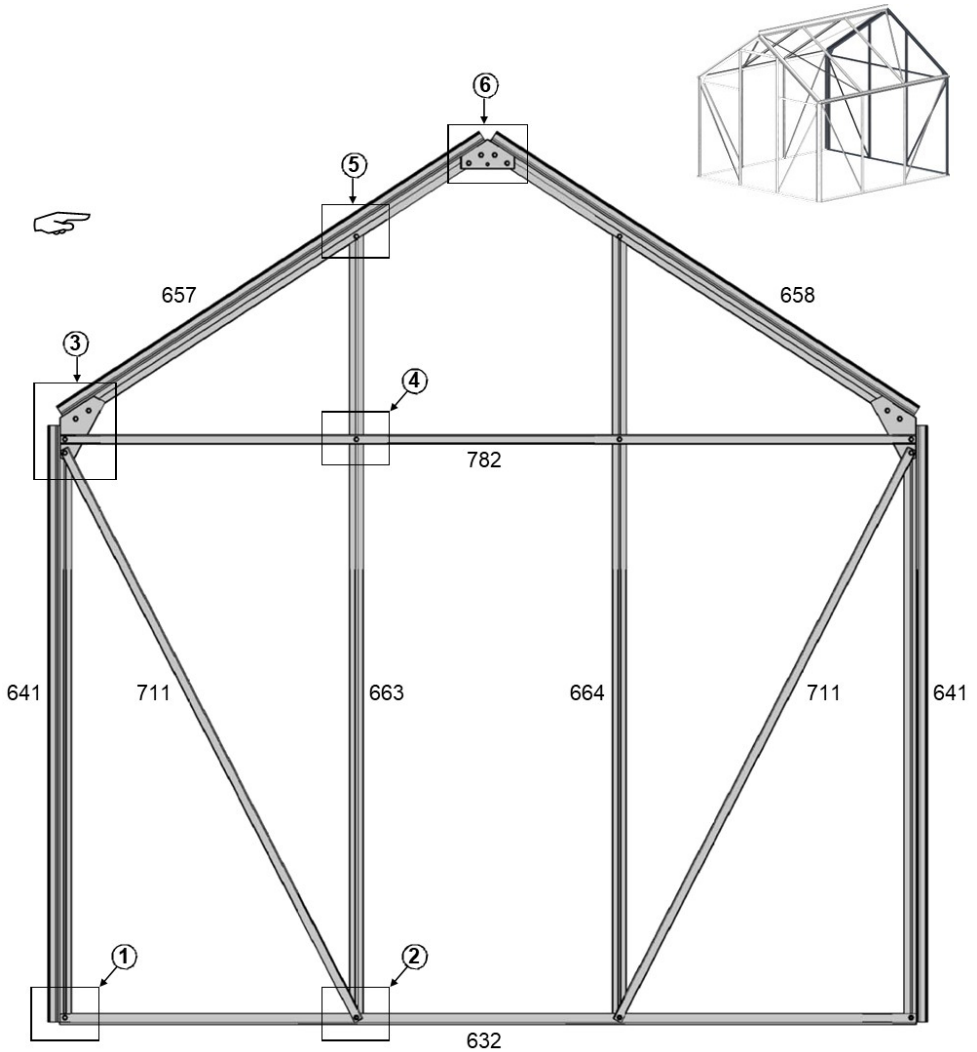

Rear gable

PACKAGE 2

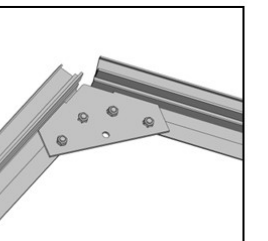
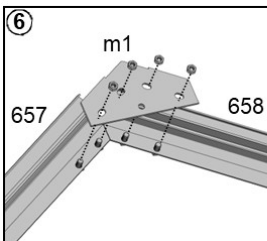
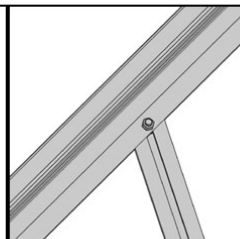
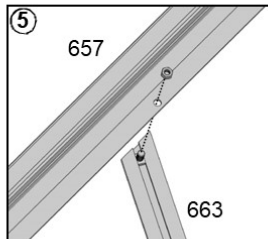
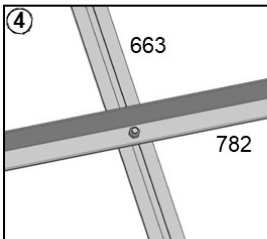
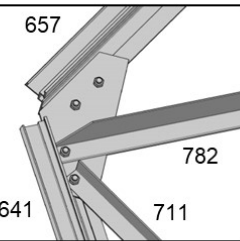
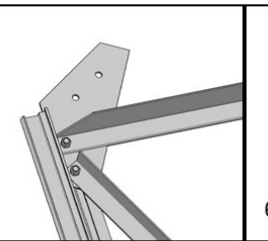
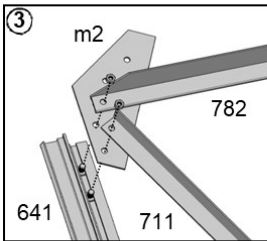
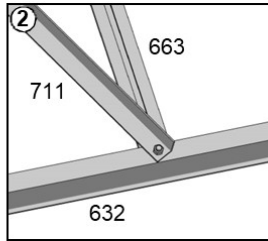
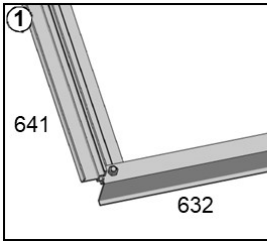







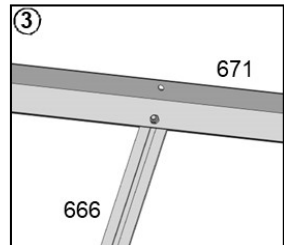
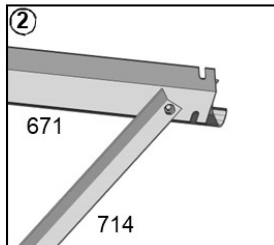
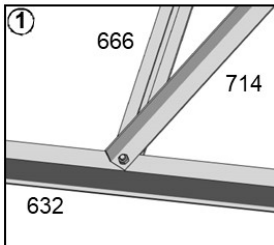
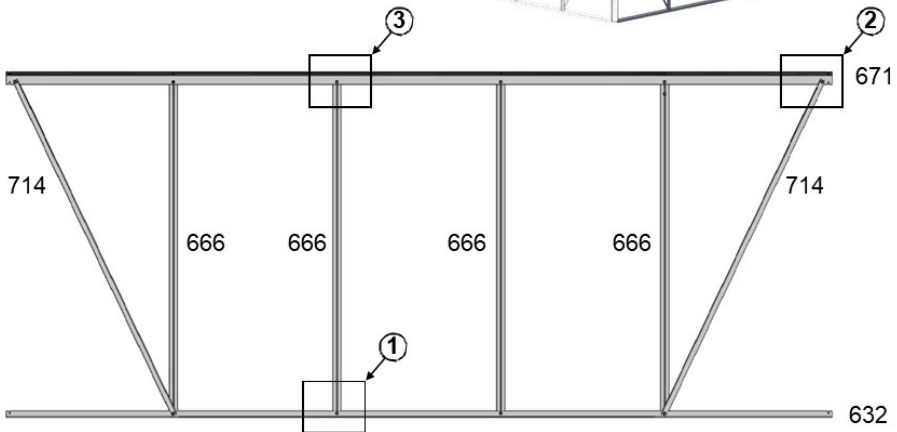
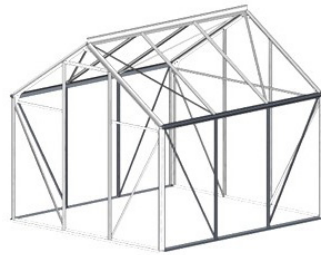

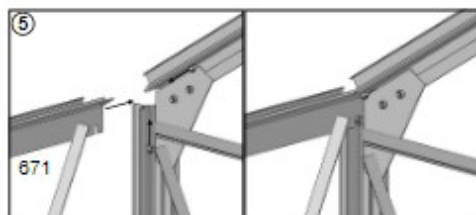
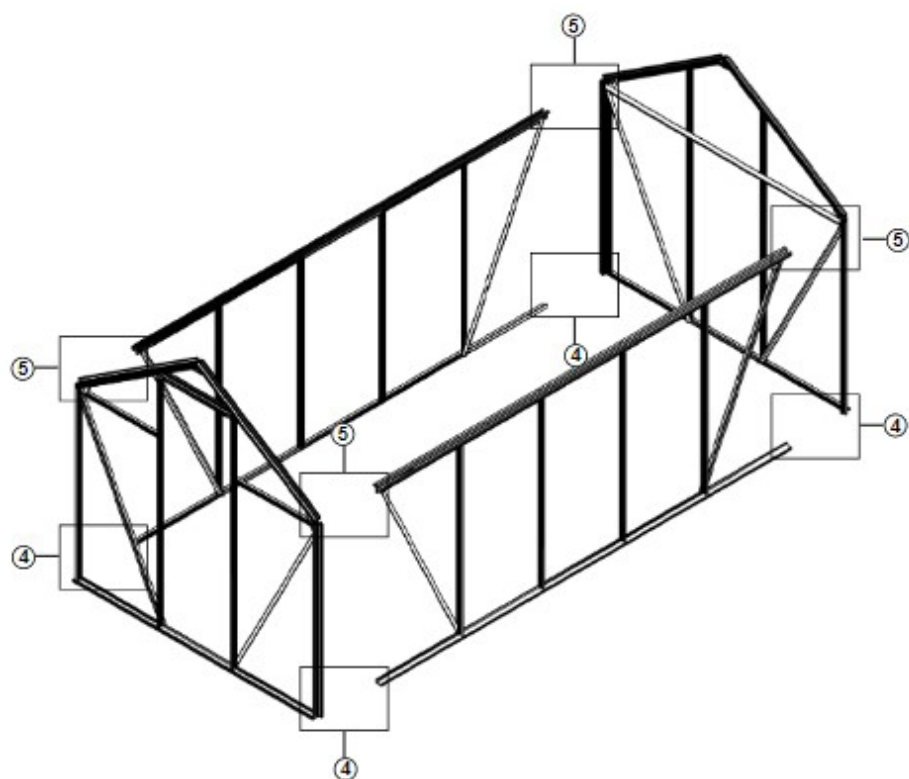
Side wall

PACKAGE 3

3														
#	632					666	671					714	a1	a2
Size	1414	2108	2802	3496	4190	1415	1414	2108	2802	3496	4190	1565	M6x10	M6
—				2		8				2		4	28	28





4											
#	701					682	715	751	a1	a2	B-p1
Size	1414	2108	2802	3496	4190	1198	1375	400	M6x10	M6	-
				1		8	4	4	36	36	2

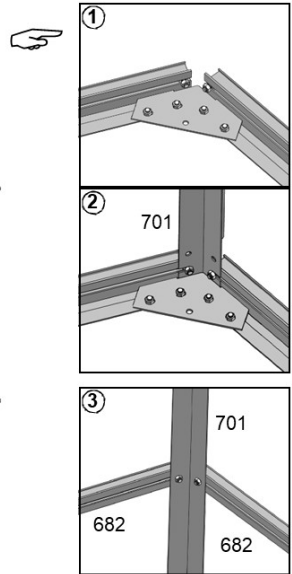
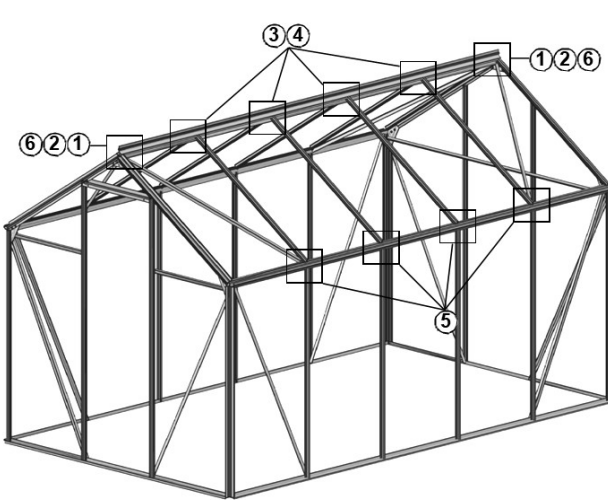

③④ Note: Please add extra bolt into channel for ridge and intilever or window use in advance.

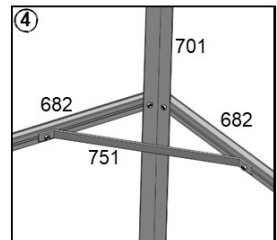
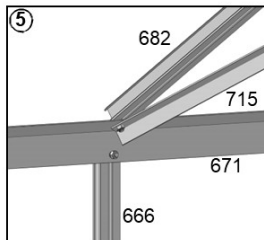
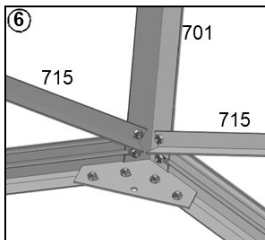

Glass

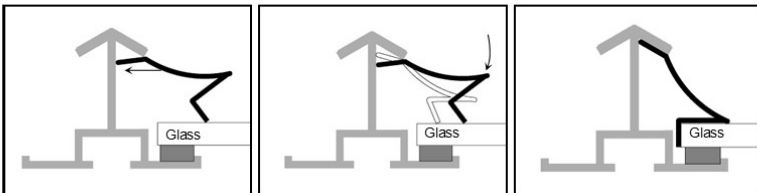
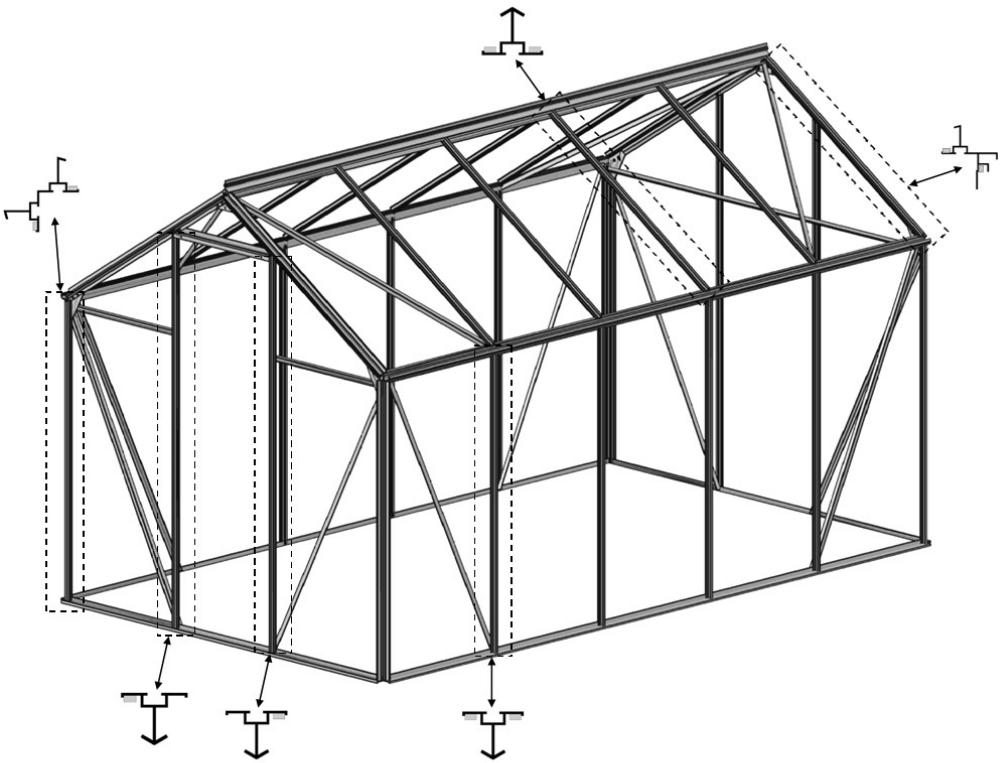
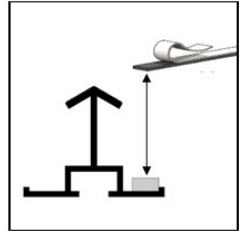

Glass

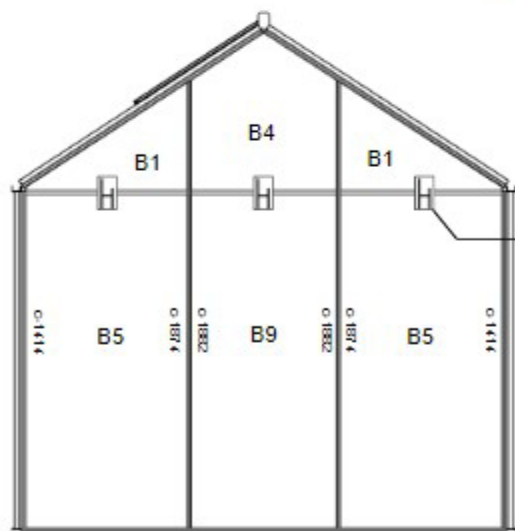
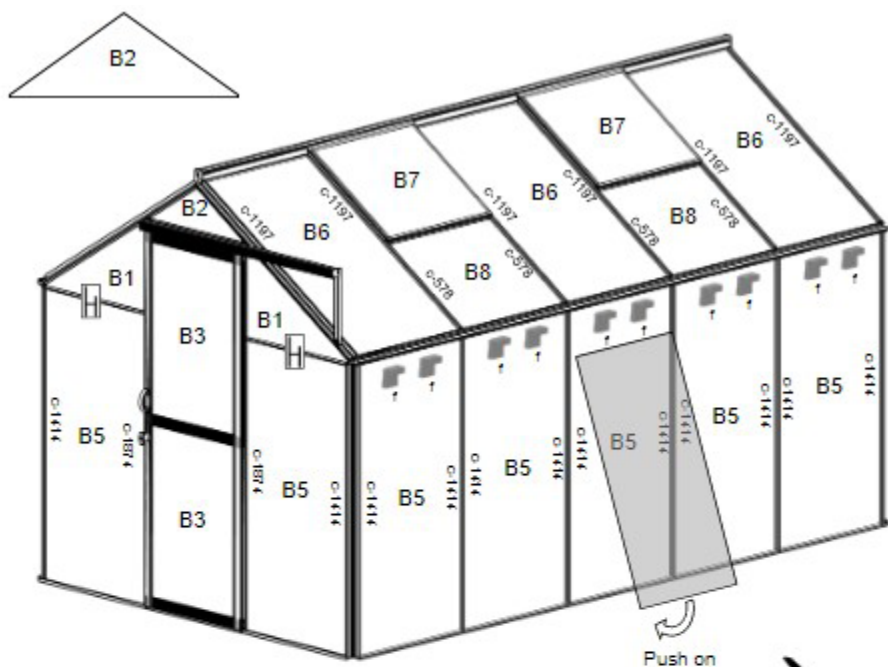





If you feel PVC size not correct, please use scissors to cut it.



Glass

#	mm	
B1	677 x 23 / 462	4
B2	609 x 18 / 215 / 18	1
B3	572 x 843	2
B4	609 x 474 / 671 / 474	1
B5	677 x 1412	14
B6	677 x 1203	6
B7	677 x 624	4
B8	677 x 585	4
B9	609 x 1412	1
H	660	4
	592	1
	5 meter	15 roll

		DWG	Length				DWG	Length	
Front Gable	c		1414	2	Rear Gable	c		1414	2
			1874	2				1874	2
Roof	c		578	8	Side wall	c		1414	20
			1197	12				f	

5													
#	571	581	582	583	591	592	791	594	384	p4	p5	m10	n1
Size	1265	623	633	633	1822	1822	359	830	-	-	-	-	-
QTY	1	1	1	1	1	1	1	4	1	2	2	2	4

#	a1	a2	a5	a6	a9	a11
Size	M6x10	M6	Φ3.5x19	Φ3.5x25	M4	M4x25
QTY	8	8	12	4	2	2

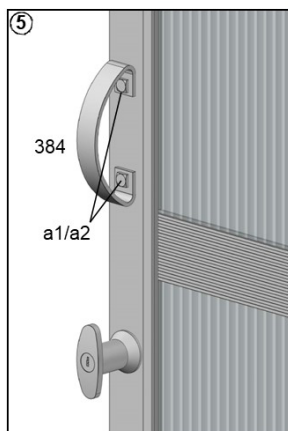
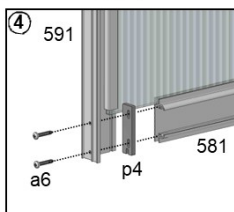
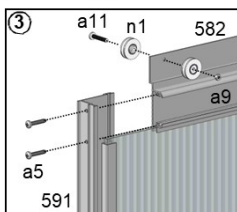
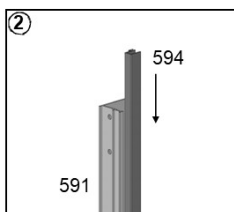
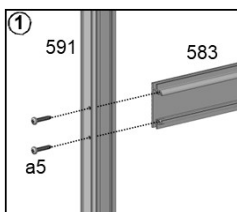
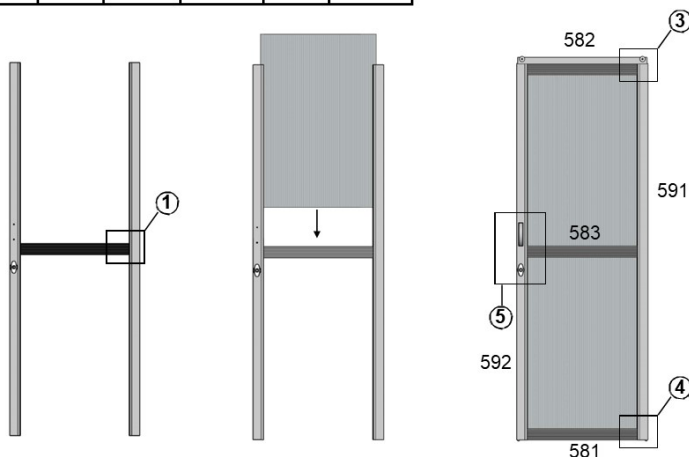

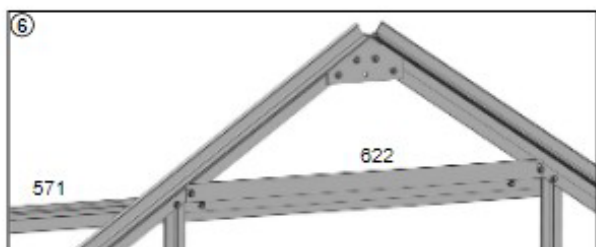
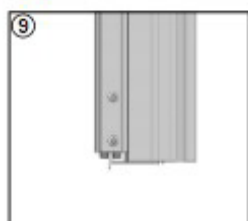
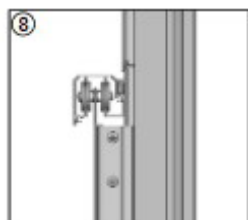
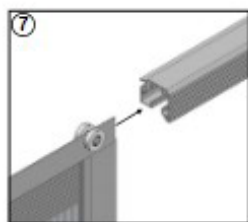
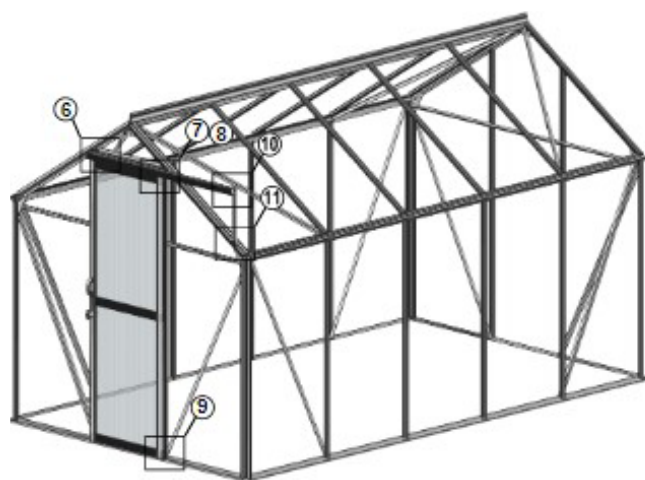

Section View

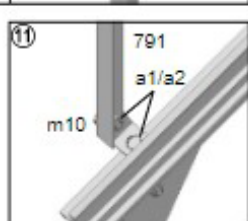
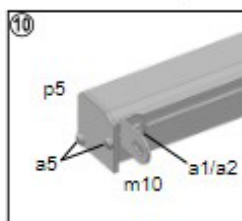
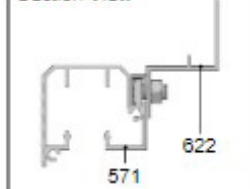

6												
#	521	541	531	551	201	a1	a2	a4	a7	a9	p3	p10
Size	724	695	601	678	300	M6x10	M6	Φ3.9x8	M4x8	M4	-	-
QTY	1	1	2	1	1	8	8	2	2	2	2	1

Vent No.	4
----------	---

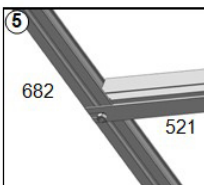
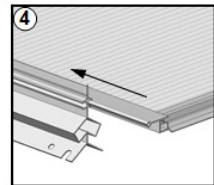
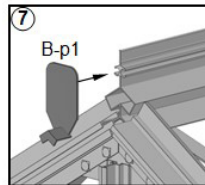
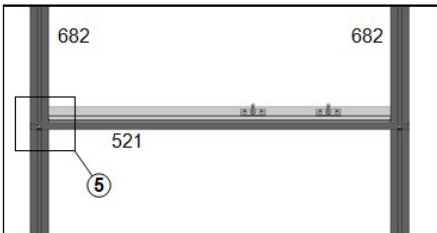
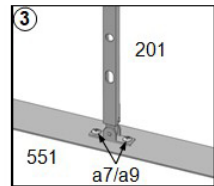
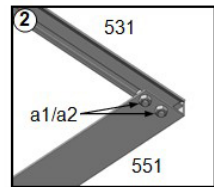
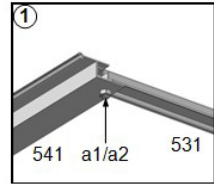
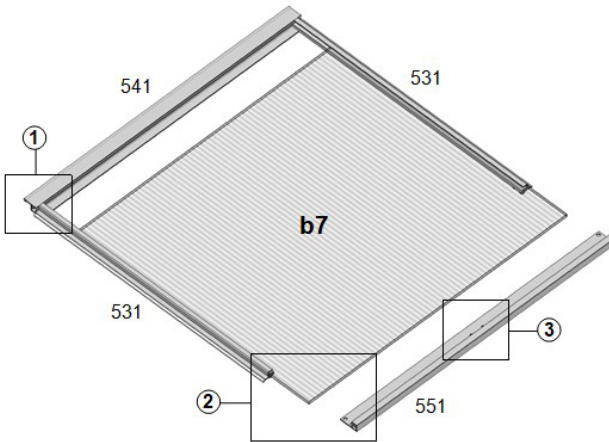



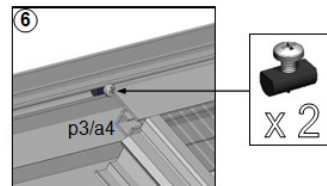



Plastic p3 is used on both sides of the window to keep it from moving side to side. The screw a4 will expand the plastic p3 and hold it firmly.

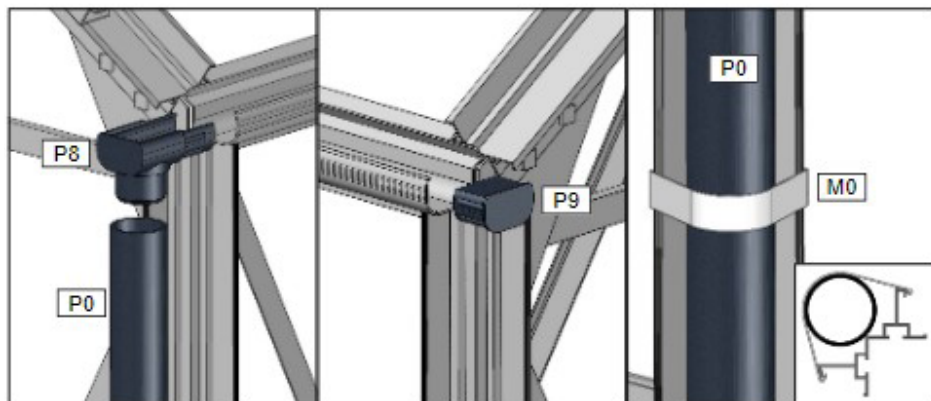
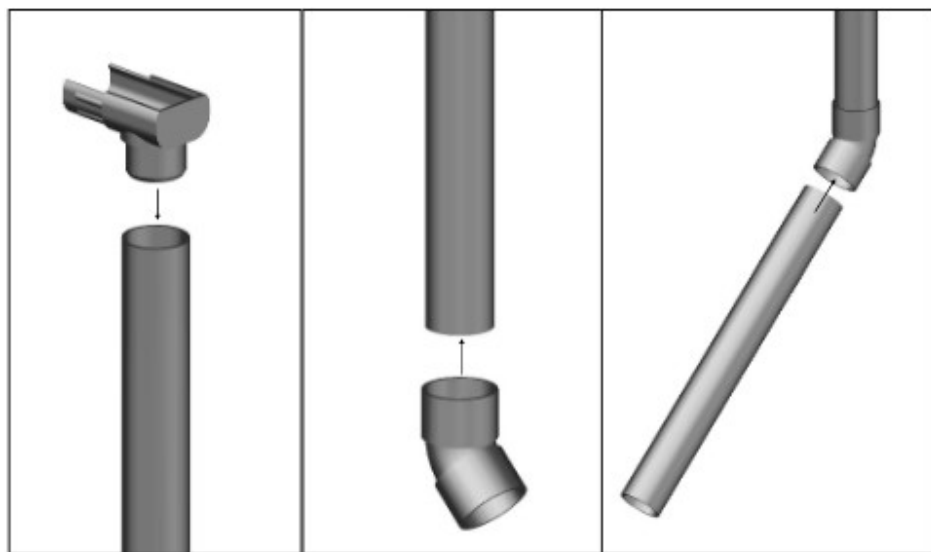

Once you located the window, before assembling roof panel, please insert p3 through ridgepole channel to fix window tightly.

Rain water kit



						
#	P8	P9	M0	P1	P0	P2
mm					800	200
QTY	2	2	2	2	2	2

Vi gratulerar dig till köpet av ditt nya växthus Green Land Galea. Vi hoppas att växthuset ger glädje åt trädgårdsarbetet och framgång i odlingen av växter och grönsaker. Läs monteringsanvisningarna nedan noggrant innan du börjar montera och se till att du har alla delar som anges i delförteckningen och de verktyg som behövs för monteringen. Spara denna bruksanvisning för framtida referens.

TEKNISK INFORMATION

- » BREDD: 212,5 CM
- » LÅNGD: 354,3 CM
- » HÖJD (PÅ BASEN): 140/219,5 CM
- » VIKT: 245 KG
- » STORLEK: 7,53 M²
- » RAMENS FÄRG: SVART
- » RAMENS MATERIAL: ALUMINIUM
- » RAMENS TJOCKLEK: 1,3–3,0 MM
- » TAK- OCH VÄGGPANELER: 3 MM HÄRDAT SÄKERHETSGLAS
- » BAS: 10 CM HÖG ALUMINIUMBAS
- » VENTILATION: TVÅ TAKÖPPNINGAR SOM ÖPPNAS MANUELLT
- » DÖRR: LÅSBAR SKJUTDÖRR
- » GARANTI: 10 ÅR FÖR RAMEN

VARNINGAR OCH MEDDELANDEN

- » *Kontrollera lokala lagar och bestämmelser innan du monterar ditt växthus.*
- » *Hitta en plan och stabil plats för växthuset. Om marken eller grunden inte är jämn får du inte installera växthuset på den platsen. Börja med att se till att grunden är jämn.*
- » *Installera växthuset endast under goda väderförhållanden. Montera inte växthuset på en blåsig dag.*
- » *Det rekommenderas att växthuset monteras av minst 2–3 personer.*
- » *Observera att växthuset består av många delar och tillbehör och att det tar tid att montera det.*
- » *Välj en plats där du har tillräckligt med utrymme för att arbeta runt växthuset.*
- » *Bär skyddshandskar och en långärmad skjorta när du monterar växthuset. Den kan ha vassa kanter som kan orsaka repor eller skärsår.*
- » *Se till att växthuset är väl fastsatt i basen och grunden så att det inte kan röra sig i starka vindar.*
- » *Klättra inte upp på växthusets tak. Risk för kollaps.*

- › *Ett växthus är endast stabilt om det är monterat på en jämn och stabil grund, med alla hörn i enlighet med de ursprungliga planerna. Fel eller brister som gör att väggarna lutar kan orsaka instabilitet och leda till att glaspaneler lossnar eller andra strukturella problem.*

GARANTIVILLKOR

Växthusets 10-åriga garanti täcker utbyte av defekta delar på grund av material- och tillverkningsfel. Garantin börjar gälla från och med det inköpsdatum som anges på kvittot, som måste sparas under hela garantitiden. Garantin omfattar ramen och de delar och tillbehör som behövs för att montera ramen. Skador på glastror täcks inte av garantin. Garantin täcker inte skador som orsakats under transport eller montering av växthuset. Garantin täcker inte heller skador som orsakats av extrema väderförhållanden eller för stor snöbelastning. Växthuset måste monteras i enlighet med dessa anvisningar, annars är garantin inte giltig.

VINTERSKYDD

Green Land Galea är byggd med en ramtjocklek som är starkare än de flesta konkurrerande produkter på marknaden. Vi rekommenderar ändå att du skyddar ditt växthus väl för att hålla det i gott skick under vintern. Ta del av nedanstående förslag på hur du kan hålla ditt växthus intakt under vintern.

- › *Ta bort snölasten från taket regelbundet och alltid efter kraftiga snöfall. Snölasten över 10 cm kan vara farliga på grund av den höga vikten av våt snö.*
- › *Stöd den centrala delen av växthusets tak med en stödpelare.*
- › *Placera växthuset på en plats där det inte utsätts för stora snölasten från träd eller andra konstruktioner.*

UNDERHÅLL

Green Land Galea växthus är föremål för en strikt kvalitetskontroll och vi förväntar oss att du får en felfri produkt. Följ underhållsinstruktionerna nedan för att hålla ditt växthus i gott skick.

- › *Alla gångjärn och skjutdörrskenor måste smörjas regelbundet för att säkerställa att de fungerar korrekt.*
- › *Rengör löv och annat skräp från rämnorna regelbundet.*
- › *Förhindra vindskador genom att stänga ventilerna och dörren vid starka vindar.*
- › *Du kan rengöra ramens ytor med ett mildt rengöringsmedel. Använd inte slipande rengöringsmedel.*
- › *Du kan rengöra glasytor med fönsterputs.*
- › *Rengör växthuset noggrant både före och efter odlings säsongen.*

Läs igenom instruktionerna och kolla de tillbehör du behöver innan du börjar montera ditt växthus. Anvisningarna presenteras i en kombination av text och bilder. Montera växthusramen sektion för sektion. Bultarna och de olika tillbehören för alla delar finns i samma paket tillsammans med denna handbok.

Varje paket anges i delförteckningen. Alla detaljerade bilder är markerade med en symbol:



SETT INIFRÅN



SETT UTFRÅN

DEL 1 – GRUND

Växthuset levereras med en aluminiumbas av hög kvalitet och det rekommenderas att växthuset monteras med denna bas. Det finns många olika sätt att bygga en grund för ett växthus. I den här guiden presenteras två populära metoder som båda använder det aluminiumbasen som levereras med växthuset. Installera växthuset antingen på en gräsmatta eller på marken med hjälp av den medföljande aluminiumbasen, eller på en stadig betongbas. Betongbasen kan antingen fungera som växthusets golv eller så kan grunden byggas precis under växthusets väggar. Vid installation på betong är det frivilligt att använda aluminiumbasen, men det rekommenderas. Installationsanvisningarna nedan gäller installation på aluminiumbasen.

FÖRTECKNING ÖVER BASENS DELAR

- » ALUMINIUMPROFIL 203,8 CM X 2 ST.
- » ALUMINIUMPROFIL 349,4 CM X 2 ST.
- » FÖRANKRINGSBEN X 6 ST
- » MONTERINGSFÄSTEN X 12 ST
- » M6-BULTAR X 20 ST
- » M6-BULTAR MED AVKLIPPT ÄNDE X 12 ST.
- » M6-MUTTRAR X 32 ST.
- » BRICKOR X 8 ST.

RIKTLINJER FÖR ALTERNATIV 1: Installation på gräsmatta eller mark med aluminiumbasen

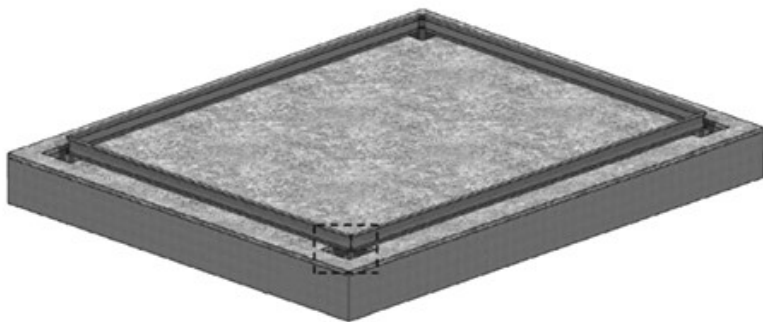

Läs igenom installationsstegen noggrant innan du börjar och se till att du har alla nödvändiga verktyg, material och förnödenheter till hands.

MONTERINGSSTEG

1. *Montera förankringsbenen i hörnen av ramen och i mitten av långsidorna. När du monterar förankringsbenen i betong ska du böja de nedre delarna av hörnbenen för att säkerställa bättre förankring.*
2. *Gräv hål ca 80 cm djupt i marken där förankringsbenen ska placeras, så att grunden ligger under tjäldjupet. Placera rör med en diameter på ca 200 mm i hålen för betongen och fyll dem med betong.*
3. *Tryck förankringsbenen i betongen. Grunden måste vara helt plant och hörnen måste vara exakt 90 grader. Du kan mäta de diagonala måtten på grunden och se till att de är lika stora. Då är vinklarna korrekta.*
4. *Avståndet mellan grunden och betongen bör vara ca 5 mm. Du kan använda ett 5 mm tjockt föremål för att säkerställa detta.*
5. *Låt betongen torka helt och hållet.*
6. *Grunden är klar och du kan börja montera växthuset på basen.*

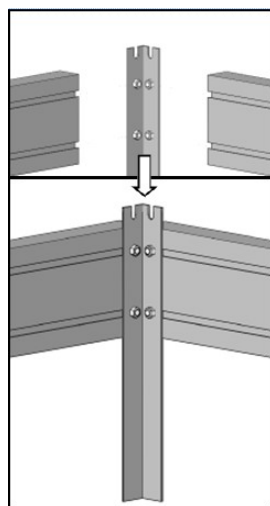

RIKTLINJER FÖR ALTERNATIV 2: Installation på en betonggrund med aluminiumbasen

Läs igenom installationsstegen noggrant innan du börjar och se till att du har alla nödvändiga verktyg, material och förnödenheter till hands.

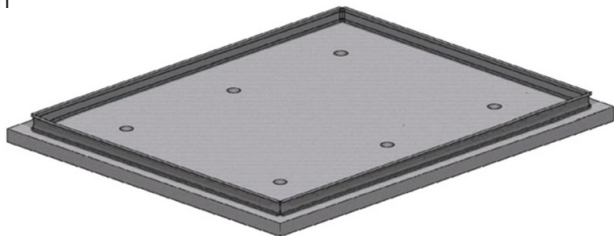

MONTERINGSSTEG

1. Bygg antingen ett betonggolv som är större än växthusets yttermått eller en betonggrund som går under växthusets väggar men inte täcker växthusets golvyta. Om du bygger grunden endast under väggarna ska du se till att grunden är minst 10 cm bred (rekommenderad bredd 30 cm) och minst 30 cm hög (rekommenderad höjd 50 cm).
2. Se till att grunden är helt plan och torr innan du monterar aluminiumbasen.
3. Förankringsbenen måste kortas av till lämplig längd, till exempel med en bågfil. Rikta in hålen i förankringsbenen och basen och korta av dem så att förankringsbenen skärs av i linje med basens botten. När det är korrekt utfört är längden på förankringsbenen cirka 19,5-20 cm.
4. Hål måste borrar i aluminiumbasen och betonggrunden, och lämpliga skruvar och förankringar måste användas för att fästa basen i grunden. Observera att borrning och skruvning måste göras i en liten vinkel på grund av aluminiumbasens form. Det rekommenderas att basen fästs på 14 punkter på grunden (2 skruvar i varje hörn, 2 skruvar på varje långsida och 1 skruv på varje kortsida). Kontakta din lokala järnaffär för att få tag på lämpliga skruvar och förankringspluggar.
5. Grunden är klar och du kan börja montera växthuset på basen.

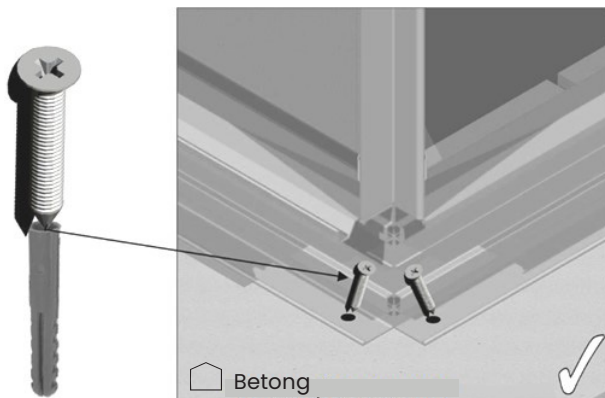
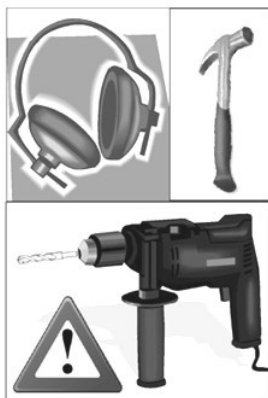

DEL II - VÄXTHUS

Bygg först växthusramen enligt instruktionerna i bilderna nedan. Fäst sedan ramen på aluminiumbasen eller direkt på en betonggrund innan du monterar glaset i ramen.

MONTERING AV RAMEN PÅ GRUNDEN

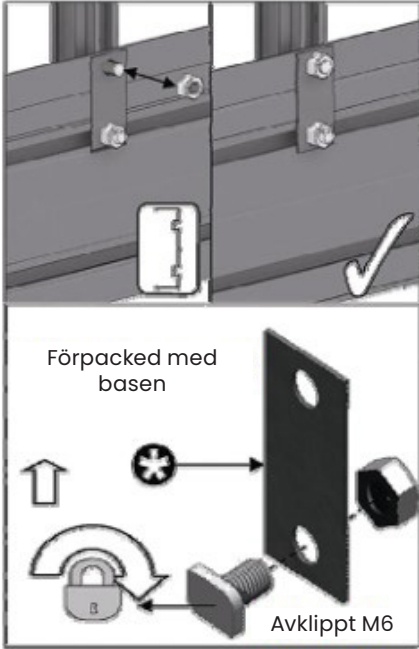

#	m7
—	12

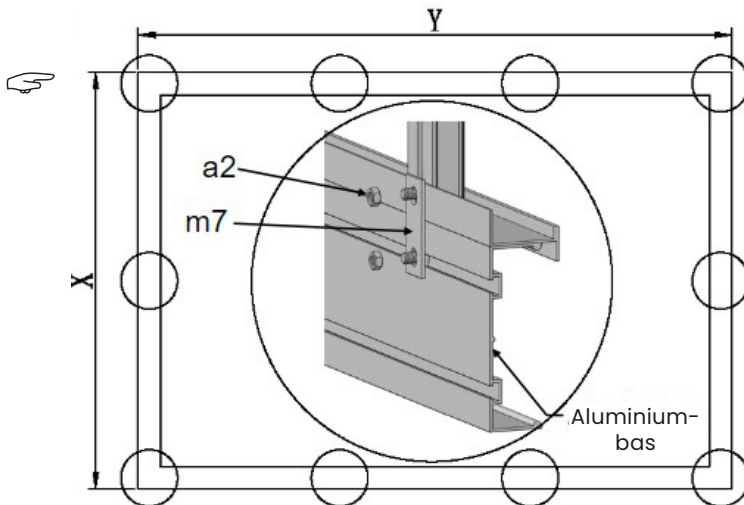

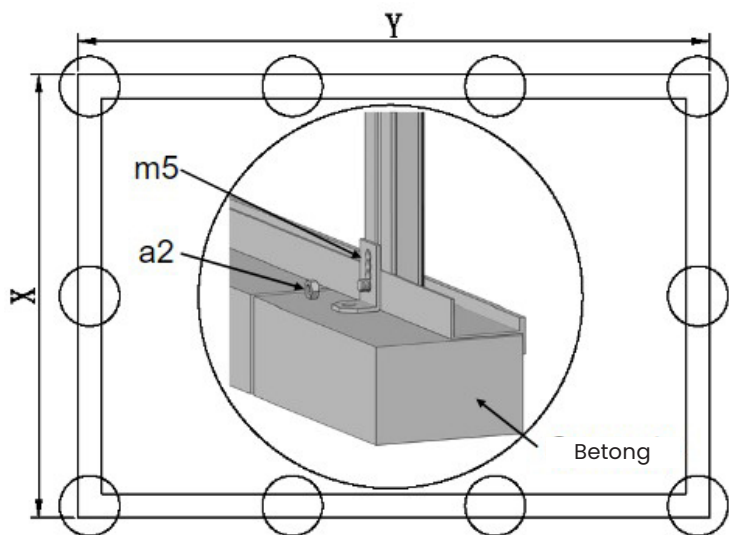

	
#	m5
—	16

	X	Y
—	2098	3554

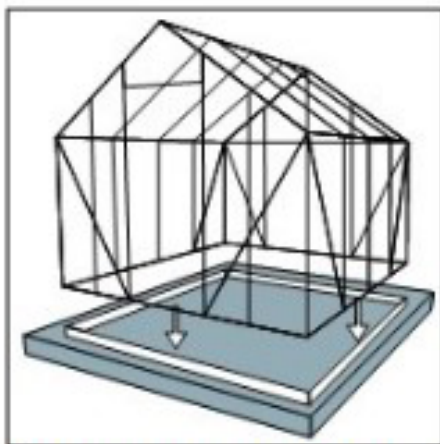
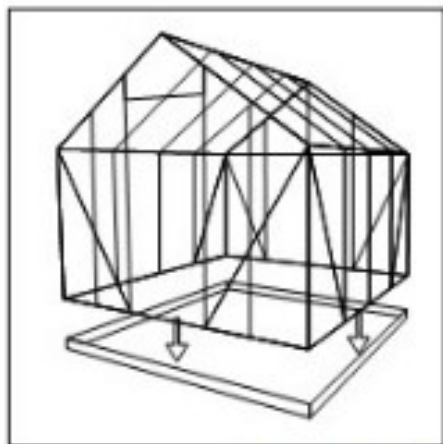

Fäst växthuset i grunden

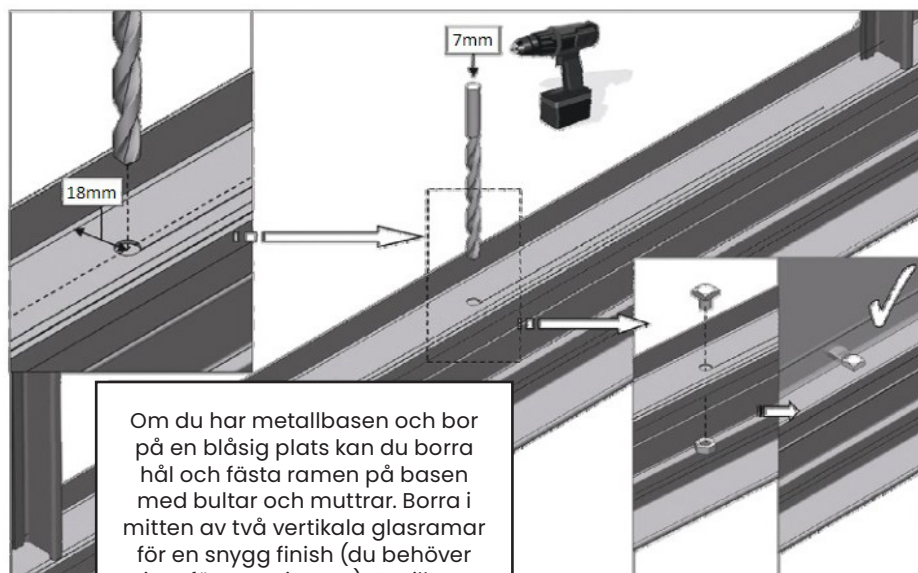

Om du har metallbasen och bor på en blåsig plats kan du borra hål och fästa ramen på basen med bultar och muttrar. Borra i mitten av två vertikala glasramar för en snygg finish (du behöver inte fästa varje ram). Se till att skruvens ände inte träffar glaset. Borra hål 18 mm från ytterkanten för att förhindra att skruven träffar glaset. Förankra inte konstruktionen i marken förrän monteringen är klar.

1															
#	612	622	641	655	656	663	664	711	712	a1	a2	a9	a14	m1	m2
Size	2038	656	1415	1198	1198	1889	1889	1526	710	M6x10	M6	M4	M4x16	-	-
QTY	1	1	2	1	1	1	1	2	2	22	22	1	1	1	2

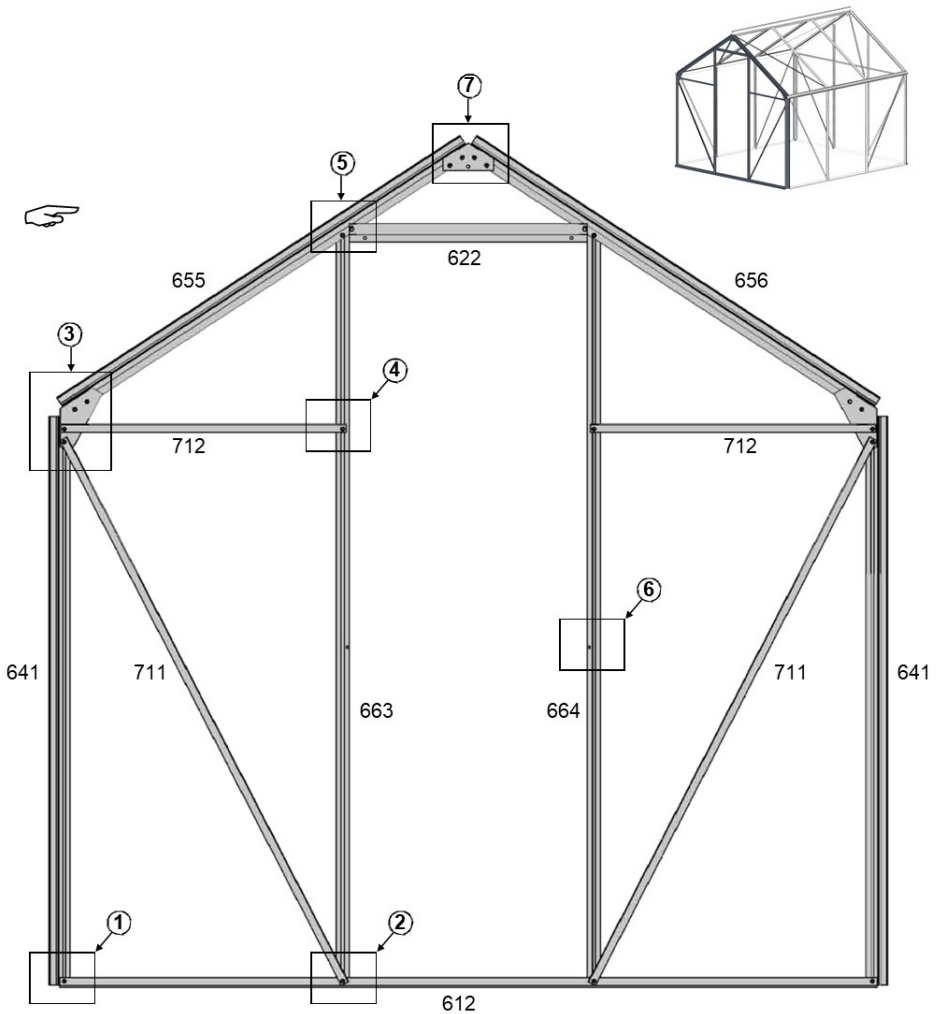

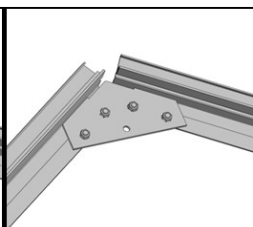
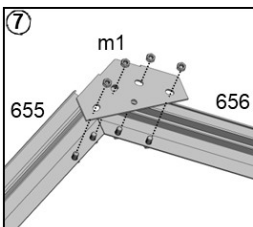
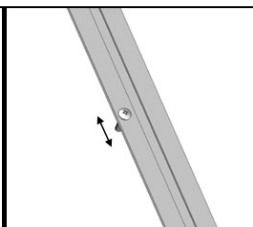
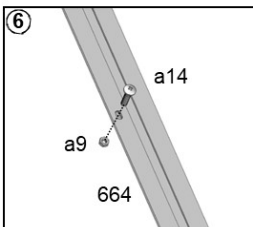
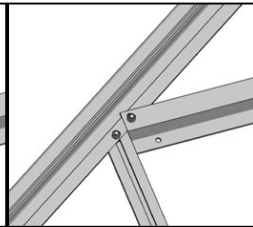
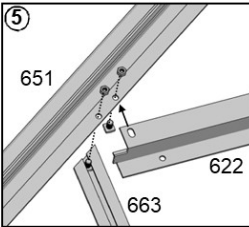
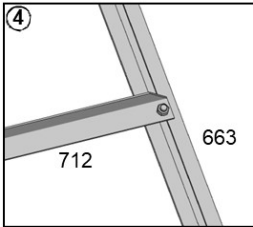
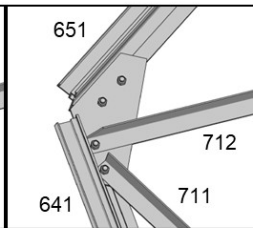
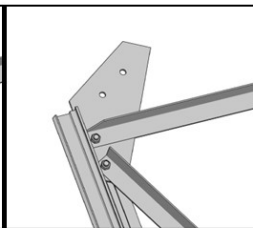
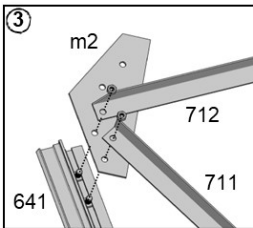
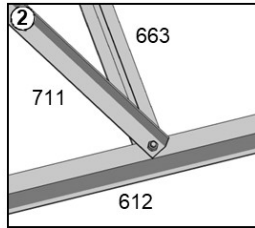
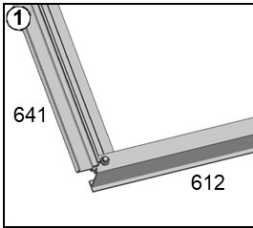

2												
#	633	641	657	658	663	664	782	711	a1	a2	m1	m2
Size	2038	1415	1198	1198	1889	1889	2036	1526	M6x10	M6	-	-
QTY	1	2	1	1	1	1	1	2	20	20	1	2

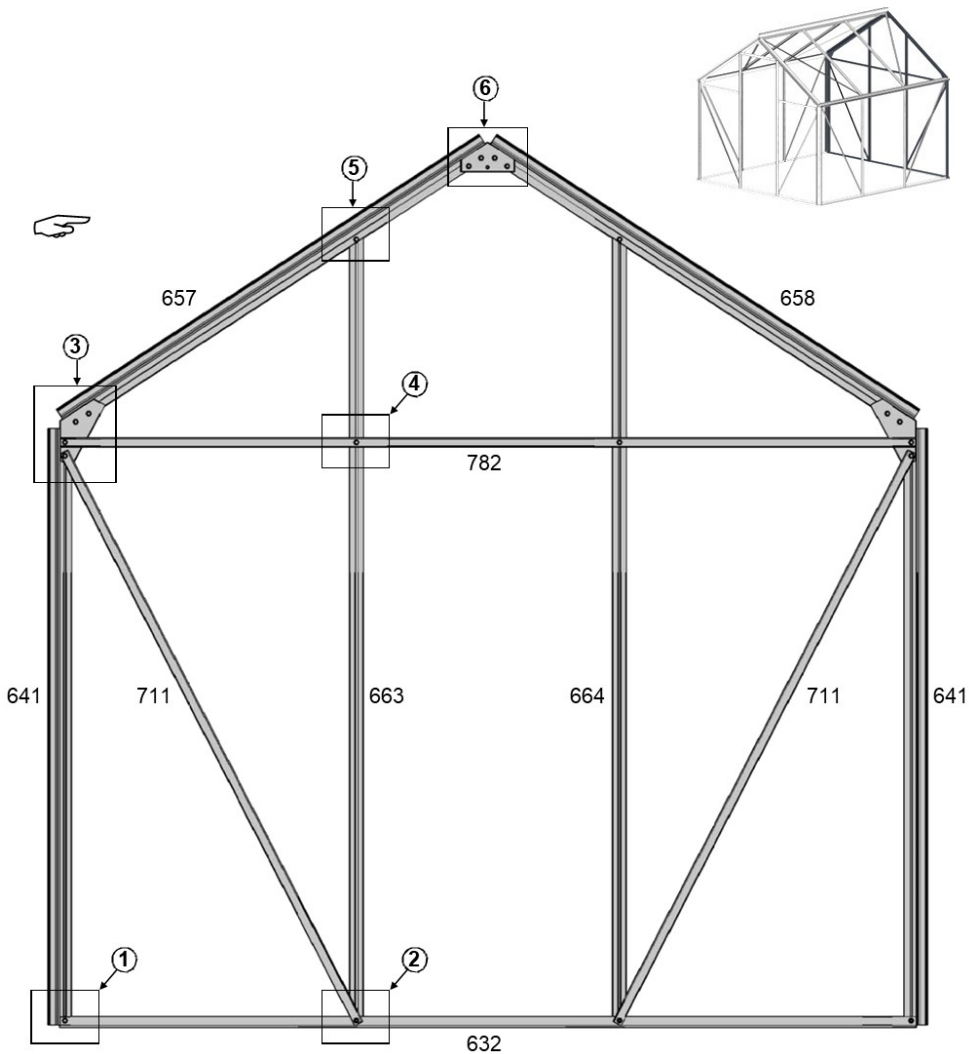

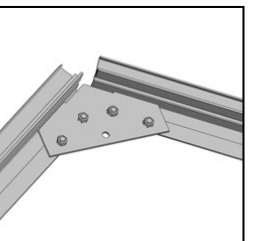
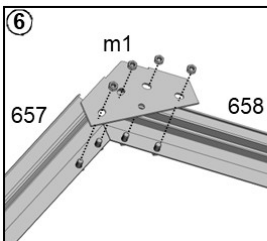
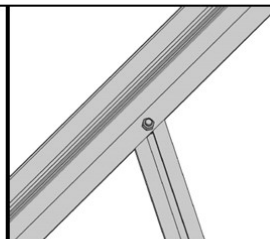
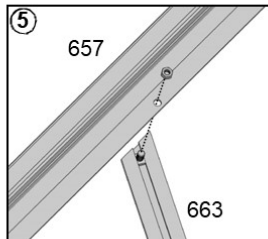
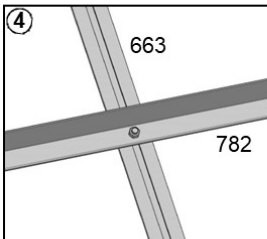
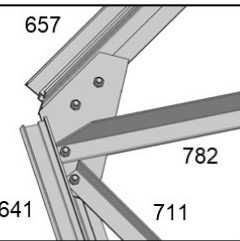
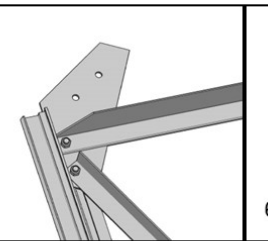
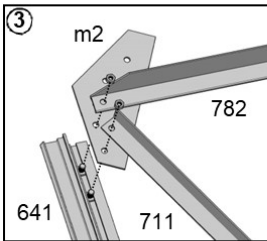
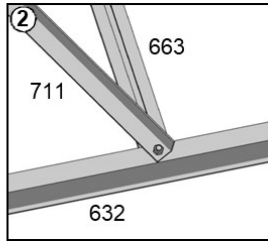
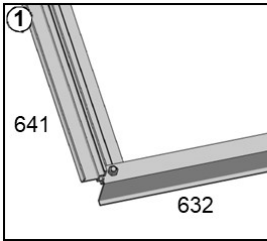

3														
#	632					666	671					714	a1	a2
Size	1414	2108	2802	3496	4190	1415	1414	2108	2802	3496	4190	1565	M6x10	M6
—				2		8				2		4	28	28

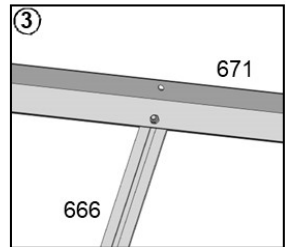
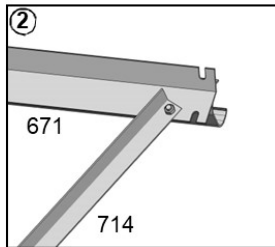
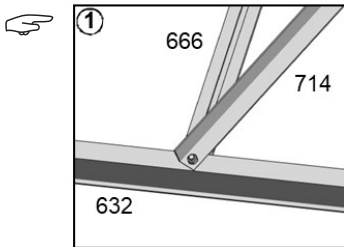
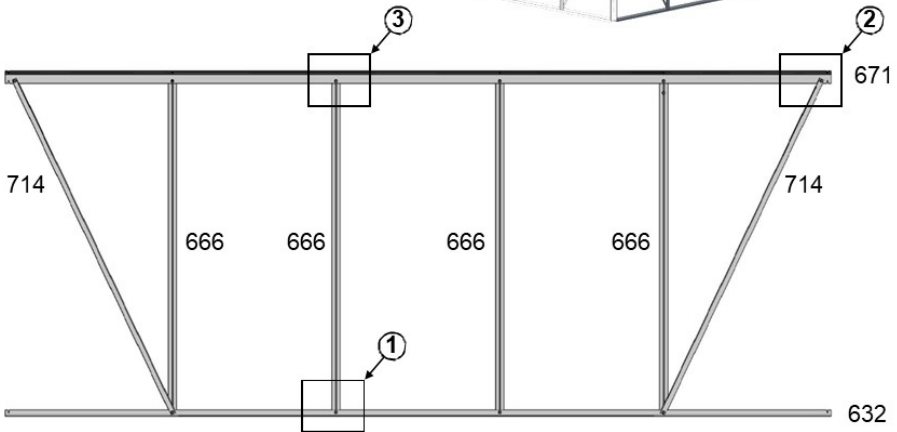
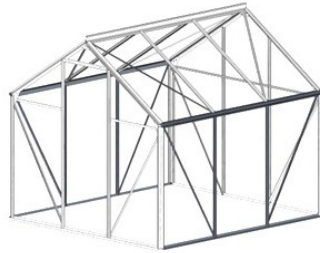

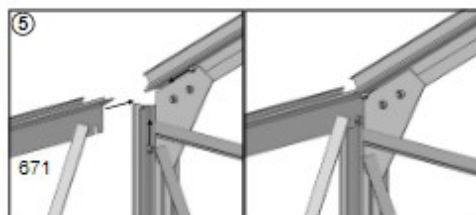
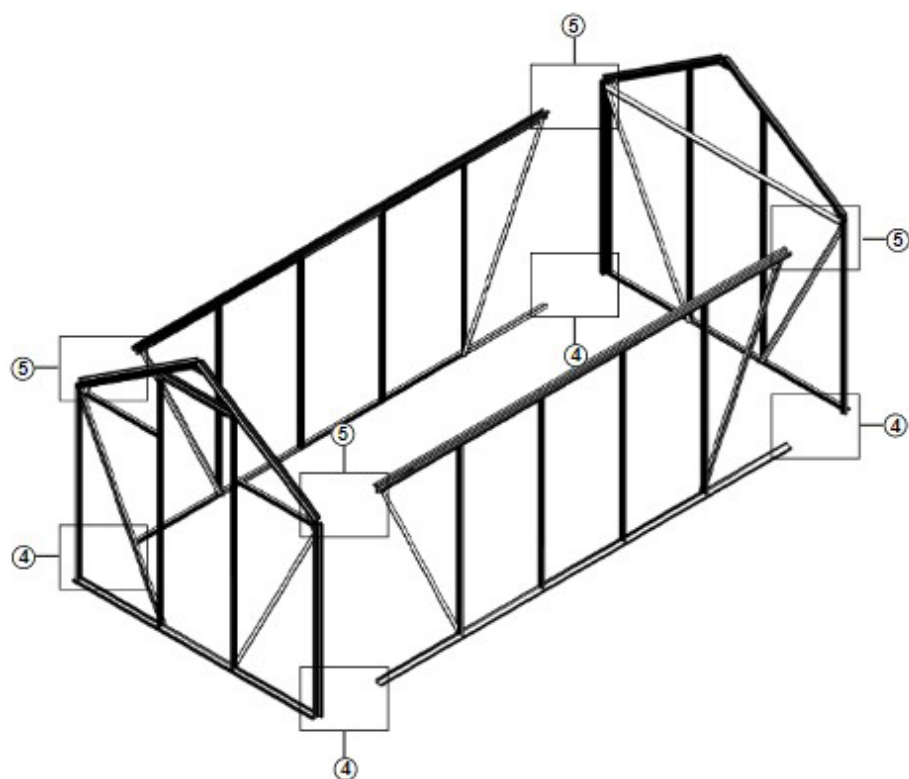

4											
#	701					682	715	751	a1	a2	B-p1
Size	1414	2108	2802	3496	4190	1198	1375	400	M6x10	M6	-
				1		8	4	4	36	36	2

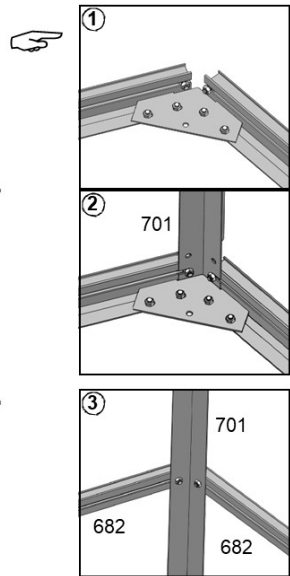
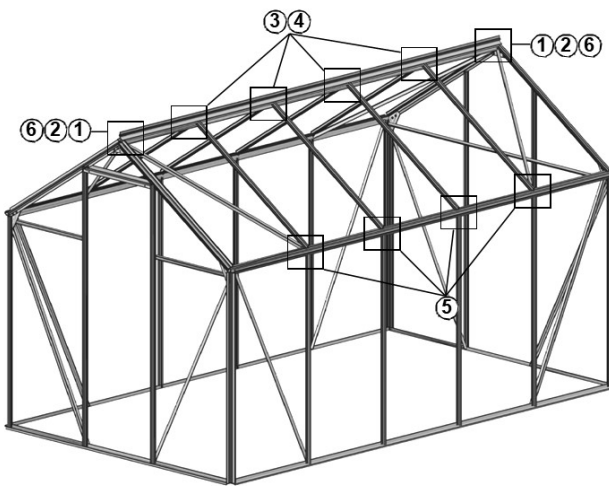

③④ Observera: Lägg till en andra skruv för takhuvens kanal eller fönster.

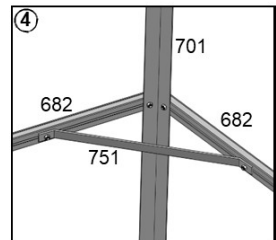
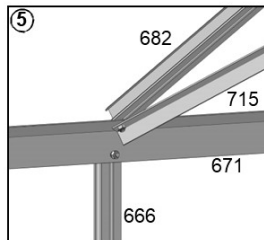
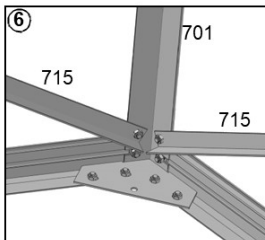

Glas

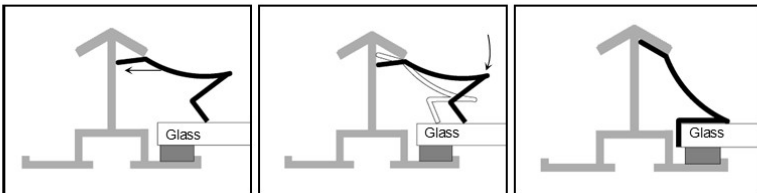
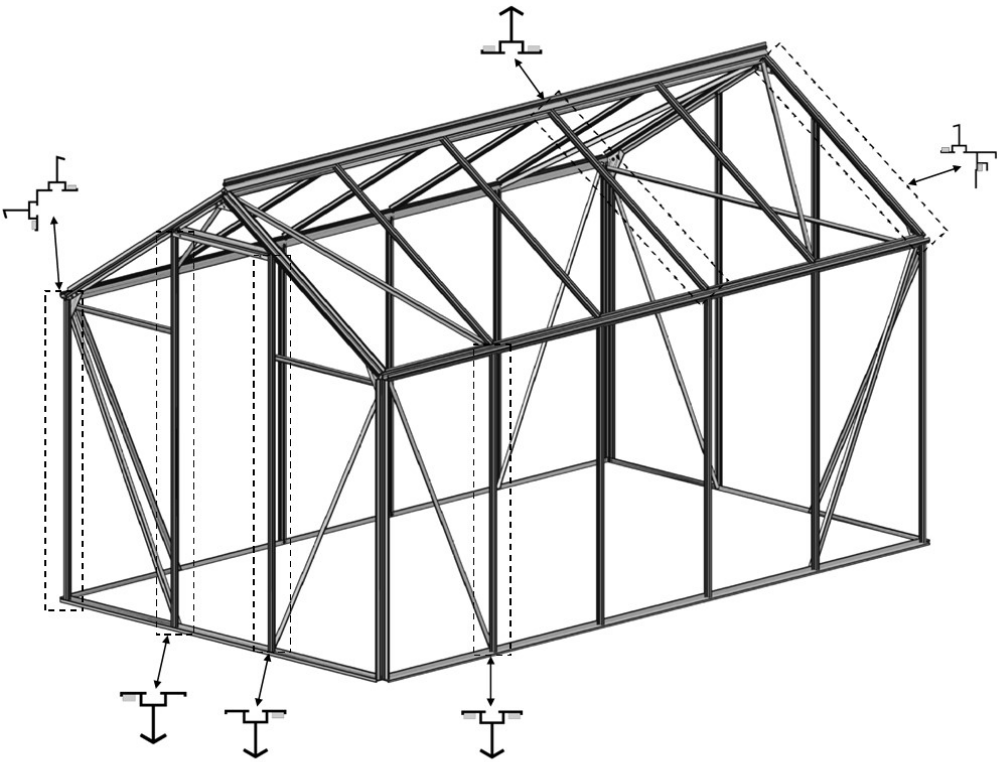
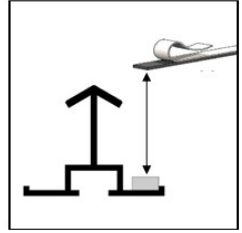

Glas

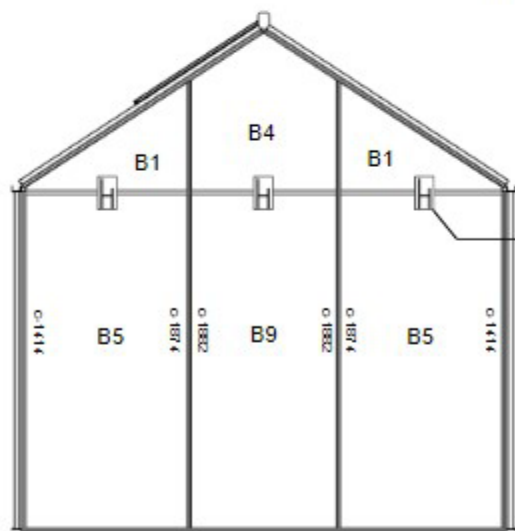
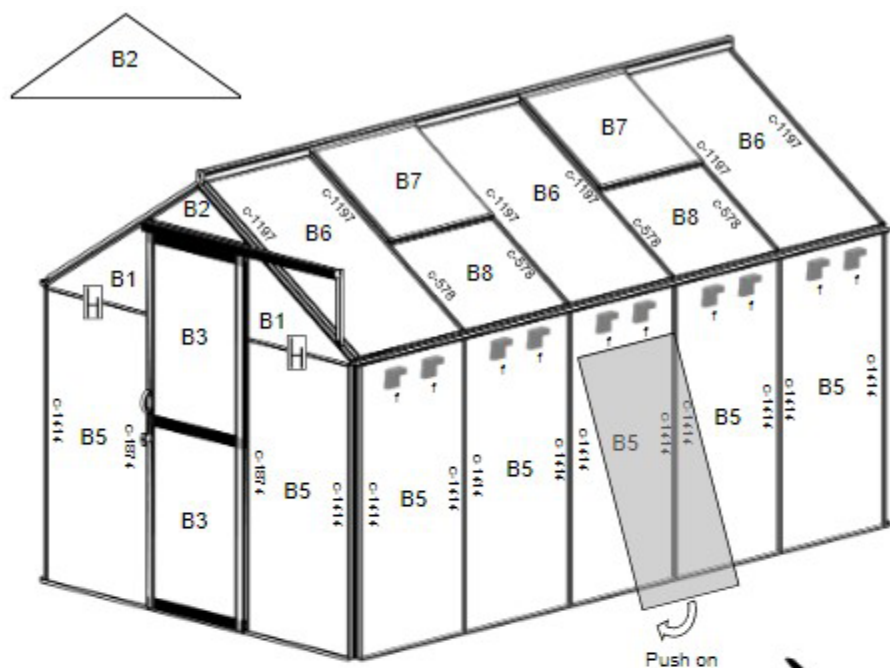





If you feel PVC size not correct, please use scissors to cut it.



Glas

#	mm	
B1	677 x 23 / 462	4
B2	609 x 18 / 215 / 18	1
B3	572 x 843	2
B4	609 x 474 / 671 / 474	1
B5	677 x 1412	14
B6	677 x 1203	6
B7	677 x 624	4
B8	677 x 585	4
B9	609 x 1412	1
H	660	4
	592	1
	5 meter	15 roll

		DWG	Length				DWG	Length	
Front Gable	c		1414	2	Rear Gable	c		1414	2
			1874	2				1874	2
Roof	c		578	8	Side wall	c		1414	20
			1197	12				f	

5													
#	571	581	582	583	591	592	791	594	384	p4	p5	m10	n1
Size	1265	623	633	633	1822	1822	359	830	-	-	-	-	-
QTY	1	1	1	1	1	1	1	4	1	2	2	2	4

#	a1	a2	a5	a6	a9	a11
Size	M6x10	M6	Φ3.5x19	Φ3.5x25	M4	M4x25
QTY	8	8	12	4	2	2

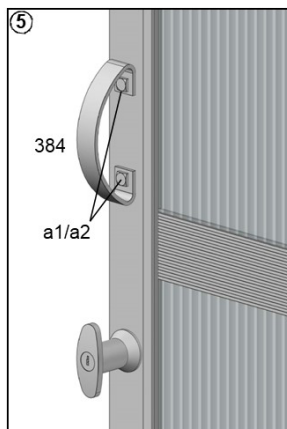
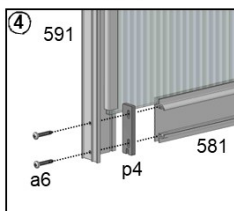
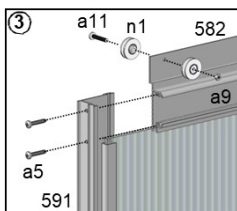
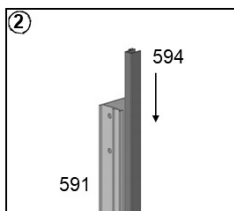
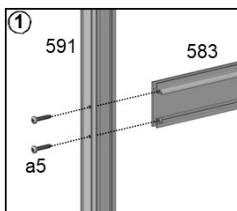
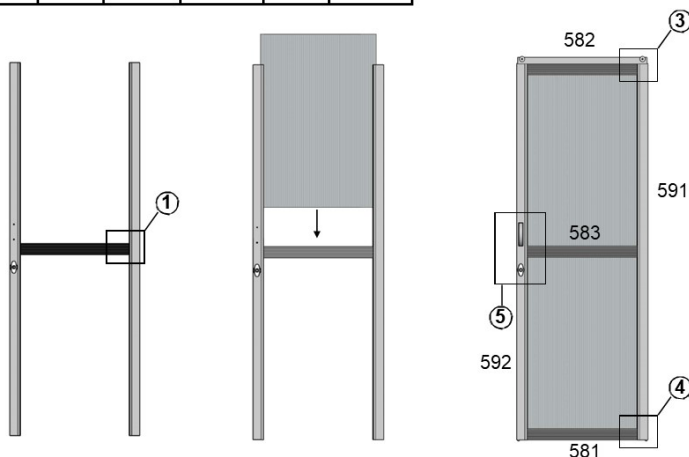

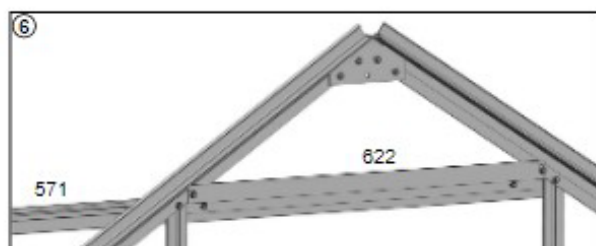
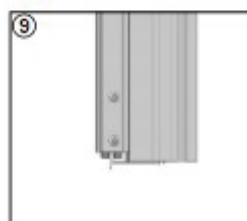
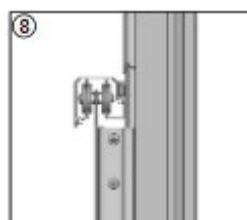
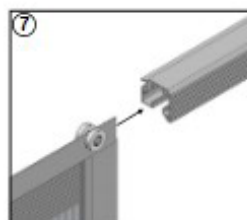
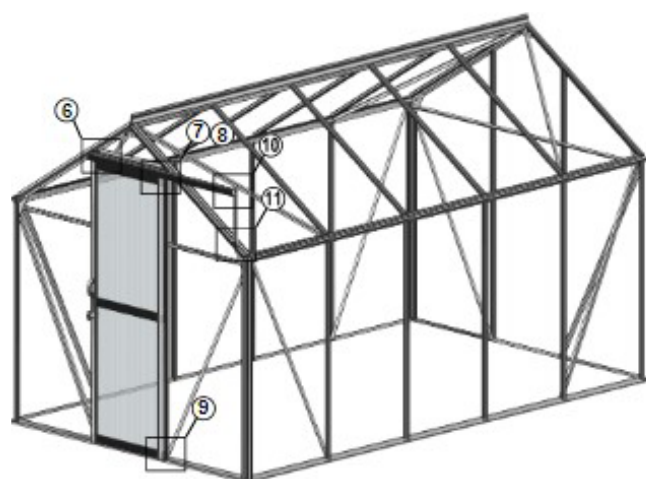

Section View

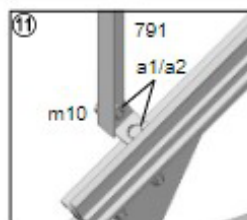
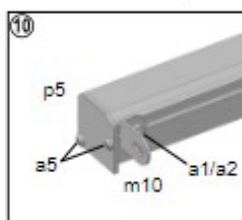
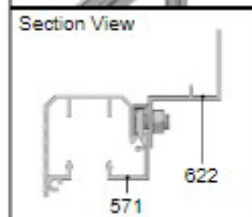

6												
#	521	541	531	551	201	a1	a2	a4	a7	a9	p3	p10
Size	724	695	601	678	300	M6x10	M6	Φ3.9x8	M4x8	M4	-	-
QTY	1	1	2	1	1	8	8	2	2	2	2	1

Vent No.	4
----------	---

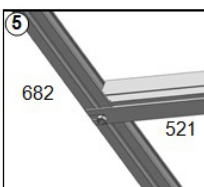
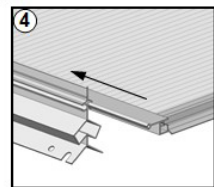
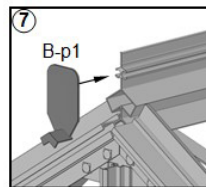
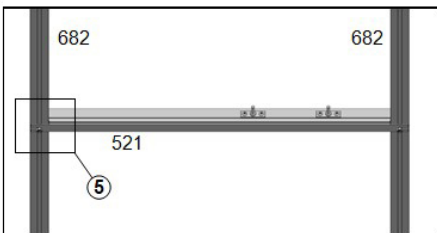
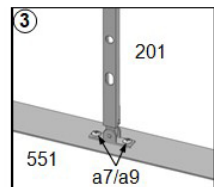
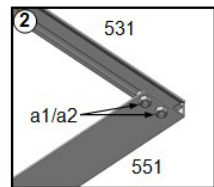
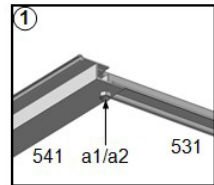
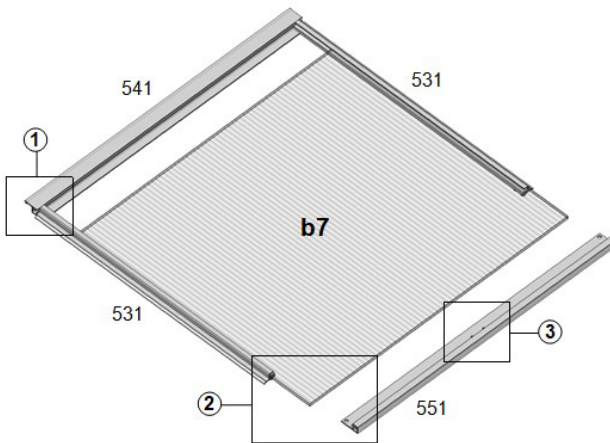



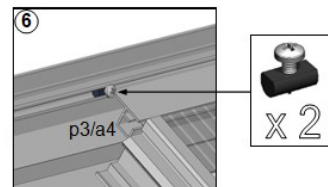



Plastdelen P3 används på båda sidor av fönstret för att förhindra att det rör sig i sidled. Skruv A4 expanderar plastdelen och håller fönstret stadigt på plats.

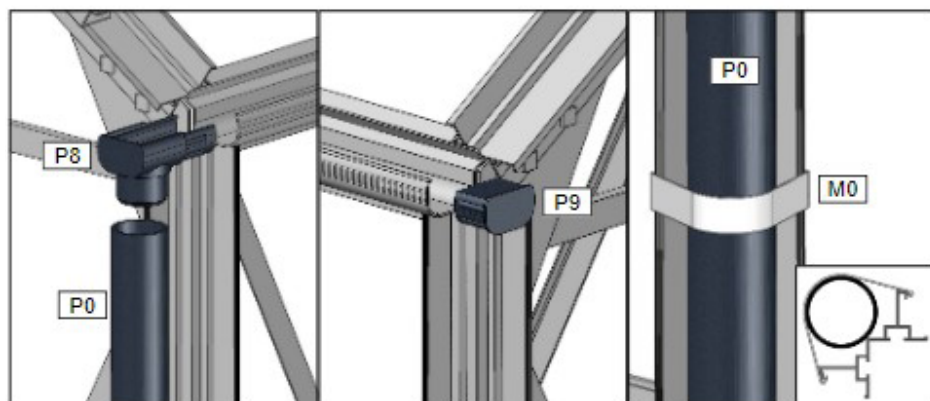
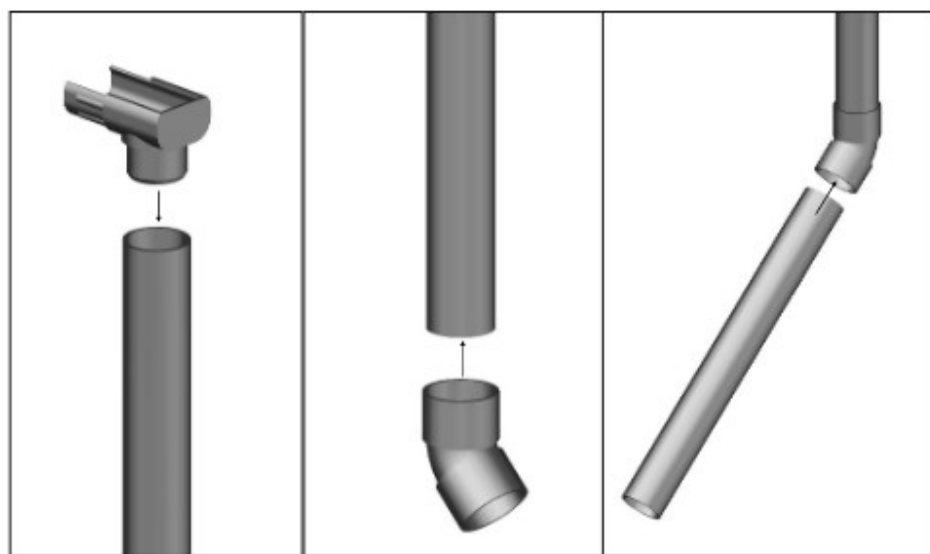

Innan du monterar takpanelen ska du sätta in plastdelen P3 i takets kanal för att se till att fönstret sitter stadigt på plats.

Taksprångsset



						
#	P8	P9	M0	P1	P0	P2
mm					800	200
QTY	2	2	2	2	2	2